

# Asymptotic expansions and extremals for the critical Sobolev and Gagliardo–Nirenberg inequalities on a torus

Michele Bartuccelli, Jonathan Deane and Sergey Zelik

University of Surrey, Department of Mathematics,  
Guildford GU2 7XH, UK (m.bartuccelli@surrey.ac.uk;  
j.deane@surrey.ac.uk; s.zelik@surrey.ac.uk)

(MS received 17 March 2011; accepted 30 October 2012)

We present a comprehensive study of interpolation inequalities for periodic functions with zero mean, including the existence of and the asymptotic expansions for the extremals, best constants, various remainder terms, etc. Most attention is paid to the critical (logarithmic) Sobolev inequality in the two-dimensional case, although a number of results concerning the best constants in the algebraic case and different space dimensions are also obtained.

## 1. Introduction

We study the critical Sobolev inequality (see [6, 16])

$$\|u\|_{C(\Omega)}^2 \leq \|u\|_{H^1(\Omega)}^2 \left( C_1 \log \frac{\|u\|_{H^2(\Omega)}^2}{\|u\|_{H^1(\Omega)}^2} + C_2 \right) \quad (1.1)$$

in the particular case when  $\Omega$  is a two-dimensional torus. This inequality, which can be formally considered as a limit case ( $l \rightarrow 1$ ,  $n = 2$ ,  $d = 2$ ) of the algebraic inequality of the Gagliardo–Nirenberg type

$$\left. \begin{aligned} \|u\|_{C(\Omega)} &\leq C_\Omega(l, n) \|(-\Delta)^{-l/2} u\|_{L^2(\Omega)}^\theta \|(-\Delta)^{-n/2} u\|_{L^2(\Omega)}^{1-\theta}, \\ \theta &= \frac{n-d/2}{n-l}, \quad n > d/2 > l, \quad \Omega \subset \subset \mathbb{R}^d, \end{aligned} \right\} \quad (1.2)$$

is known to be very useful in many problems related to partial differential equations and mathematical physics. For instance, it is used to obtain best known upper bounds for the attractor dimension of the Navier–Stokes system on a two-dimensional torus (see, for example, [30]), for proving the uniqueness of weak solutions for von Karman-type equations arising in elasticity (see [9] and references therein) as well as for the so-called hyperbolic relaxation of the two-dimensional Cahn–Hilliard equation (see [15]) or the two-dimensional Klein–Gordon equation with exponential nonlinearity (see [18]). We also mention that a slightly different logarithmic inequality is used at a crucial point in the proof of the global existence of strong solutions of the two-dimensional Euler equations (see [34]).

Note that, nowadays, most classical inequalities of Gagliardo–Nirenberg type can be easily verified using interpolation theory (see, for example, [31]). However, the best constants in those inequalities, as well as the existence and the analytic structure of the extremals, is a much more delicate and interesting question, which is far from being completely understood despite persistent interest in the problem and the many interesting results obtained during the last 50 years; see [1, 3, 5, 7, 8, 10, 12, 19–21, 23, 24, 28, 29, 32] and references therein. Most studied is the case of the whole space  $\Omega = \mathbb{R}^d$ ; more or less complete results are available in the case where the inequality does not contain derivatives of order higher than one and in the Hilbert case. In the first case, the rearrangement technique works and reduces the problem to the one-dimensional case and, in the second case, one can use the Parseval equality. In particular, as proved in [21], the best constant in (1.2) for the case  $\Omega = \mathbb{R}^d$  is

$$c_{\mathbb{R}^d}(l, n) = \left( \frac{\pi\omega(d)}{(2\pi)^d \sin((d-2l)/2(n-l))} \left( \frac{1}{(d-2l)^{d-2l} (2n-d)^{2n-d}} \right)^{1/2(n-l)} \right)^{1/2}, \tag{1.3}$$

where  $\omega(d) = 2\pi^{d/2}/\Gamma(d/2)$  is the surface area of the  $(d-1)$ -dimensional sphere. In addition, the extremal function  $u_* \in (-\Delta)^{-n/2}L^2(\mathbb{R}^d) \cap (-\Delta)^{-l/2}L^2(\mathbb{R}^d)$  exists and is unique up to a shift and scaling  $u_*(x) \rightarrow \alpha u_*(\beta x - x_0)$ ,  $\alpha, \beta \in \mathbb{R}$ ,  $x_0 \in \mathbb{R}^d$ ;  $u_*$  is given by

$$u_*(x) = \frac{1}{(2\pi)^{d/2}} \int_{\mathbb{R}^d} \frac{1}{|\xi|^{2n} + |\xi|^{2l}} e^{ix\xi} dx. \tag{1.4}$$

The situation becomes more complicated in the case where  $\Omega$  is a bounded domain of  $\mathbb{R}^d$ , even for the algebraic inequality (1.2) with Hilbert norms on the right-hand side. To the best of our knowledge, two different scenarios are possible here. In the first case, the sharp constant  $c_\Omega(l, n)$  coincides with  $c_{\mathbb{R}^d}(l, n)$  but, in contrast to the case of  $\mathbb{R}^d$ , there are no exact extremals and the approximative extremals can be constructed by the proper scaling and cutting of (1.4). This case is realized, for instance, if Dirichlet boundary conditions are posed, if  $\Omega = \mathbb{S}^1$  is a circle (periodic boundary conditions) and  $n = 0$  or if  $\Omega = \mathbb{S}^d$  is a higher-dimensional sphere ( $d = 2$  and  $\Delta$  is a Laplace–Beltrami operator), with  $n = 0$  and  $l \leq 7$ . See [20, 21] for details. In the present paper, we show that it is also true for the tori  $\Omega = \mathbb{T}^2$  and  $\Omega = \mathbb{T}^3$  if  $l = 0$  and  $n$  is not too large; see § 5. In addition, in that case, (1.2) can be improved by adding an extra lower-order term in the spirit of Brézis and Lieb (see [7]). In particular, as shown in § 5, the inequality

$$\|u\|_{C(\mathbb{T}^2)}^2 \leq \frac{1}{4} \|u\|_{L^2(\mathbb{T}^2)} \|\Delta_x u\|_{L^2(\mathbb{T}^2)} - \frac{1}{2\pi^2} \|u\|_{L^2(\mathbb{T}^2)}^2 \tag{1.5}$$

holds for all  $2\pi \times 2\pi$ -periodic functions with zero mean. However, even for this improved inequality the exact extremal functions do not exist, and further improvements can be obtained.

In the second case, the sharp constant in (1.2) is *strictly* larger than the analogous constant in  $\mathbb{R}^d$ ,

$$c_\Omega(l, n) > c_{\mathbb{R}^d}(l, n), \tag{1.6}$$

and there is/are exact extremal function(s) for (1.2) in  $H^n(\Omega)$ . In particular, this holds for  $\Omega = \mathbb{S}^2$  with  $l = 0$ ,  $n \geq 8$ ; see [21] (see also [20] for the analogous

effect for the slightly different inequality in the one-dimensional case). In that case, the constant  $c_\Omega(l, n)$  can be found only numerically as a root of a transcendental equation.

It was conjectured by Ilyin that the analogous effect holds on multi-dimensional tori  $\Omega = \mathbb{T}^d$ ,  $d > 1$  and  $l = 0$ . In the present paper, we verify that this conjecture is indeed true and that (1.6) holds for  $\Omega = \mathbb{T}^2$  (with zero mean) for  $l = 0$  and  $n = 10$ . In addition, we establish the following three-dimensional analogue of (1.5):

$$\|u\|_{C(\mathbb{T}^3)}^2 \leq \frac{\sqrt{2\sqrt{3}}}{6\pi} \|u\|_{L^2(\mathbb{T}^3)}^{1/2} \|\Delta u\|_{L^2(\mathbb{T}^3)}^{3/2} - K \|u\|_{L^2(\mathbb{T}^3)}^2, \tag{1.7}$$

where the sharp constant  $\sqrt{2\sqrt{3}}/6\pi$  still *coincides* with the analogous constant in the whole space  $\mathbb{R}^3$  but, nevertheless, (1.7) possesses an exact extremal function and the best value for the second constant  $K$  can be found only numerically ( $K \sim 0.996/2\pi^3$ ; see § 5).

We now return to limit *logarithmic* inequality (1.1). This case looks more difficult than the algebraic one, in particular, since it is not clear *a priori* whether or not the transcendental function  $\delta \rightarrow C_1 \log \delta + C_2$  ( $\delta := \|u\|_{H^2(\Omega)}^2 / \|u\|_{H^1(\Omega)}^2$ ) on the right-hand side of (1.1) is optimal. Indeed, a detailed study of the slightly different logarithmic inequality

$$\|u\|_{C(\Omega)}^2 \leq \|u\|_{H^1(\Omega)}^2 \left( C'_1 \log \frac{\|u\|_{C^\alpha(\Omega)}^2}{\|u\|_{H^1(\Omega)}^2} + C'_2 \right), \tag{1.8}$$

where the  $H^2$ -norm is replaced by the Hölder norm with  $\alpha \in (0, 1)$ , is given in recent papers [3, 19] for the case where  $\Omega$  is a unit ball and the function  $u$  satisfies the *Dirichlet* boundary conditions (see also [26, 27, 32]). As shown there,  $C'_1 > 1/4\pi\alpha$  and, in order to be able to take  $C'_1 = 1/4\pi\alpha$ , an extra double-logarithmic corrector ( $\delta \rightarrow \log \log \delta$ ) is required. Thus, based on that result and on the interpolation inequality

$$\|u\|_{C^\alpha}^2 \leq C \|u\|_{H^1}^{2(1-\alpha)} \|u\|_{H^2}^{2\alpha},$$

one may expect the improved version of (1.1),

$$\begin{aligned} & \|u\|_{C(\mathbb{T}^2)}^2 \\ & \leq \frac{1}{4\pi} \|\nabla u\|_{L^2(\mathbb{T}^2)}^2 \left( \log \frac{\|\Delta u\|_{L^2(\mathbb{T}^2)}^2}{\|\nabla u\|_{L^2(\mathbb{T}^2)}^2} + \log \left( 1 + \log \frac{\|\Delta u\|_{L^2(\mathbb{T}^2)}^2}{\|\nabla u\|_{L^2(\Omega)}^2} \right) + L \right), \quad L > 0, \end{aligned} \tag{1.9}$$

to be optimal for the case of  $2\pi \times 2\pi$ -periodic functions  $u$  with zero mean. Note that the analysis presented in [3, 19] is based on reducing the problem to the radially symmetric case via the rearrangement technique, and use of the Dirichlet boundary conditions is essential, so it is not clear how to extend it, either to the case of the torus or to the case of the  $H^2$ -norm. Nevertheless, as we will see below, (1.9) is true for the properly chosen constant  $L$  (which can be found numerically as a solution of a transcendental equation:  $L \sim 2.15627$ ). In addition, there exist exact extremal functions for this inequality; see § 3.

The main aim of the present paper is to introduce a general scheme that allows the analysis of inequalities (1.1), (1.2) and (1.9), at least on tori, from a unified point of view, and to illustrate it in the most complicated logarithmic case (although non-trivial applications to the algebraic case will be also considered). One important feature of our approach is that, in contrast to, say, [19,21] (and similarly to [3]), the concrete form of the right-hand sides in those inequalities is not postulated *a priori*, but appears *a posteriori* as a result of computations. Indeed, instead of (1.9), we consider the variational problem with constraints

$$\frac{\|u\|_{L^\infty}^2}{\|\nabla u\|_{L^2}^2} \rightarrow \max, \quad u \in H^2(\mathbb{T}^2), \quad \int_{\mathbb{T}^2} u(x) \, dx = 0, \quad \frac{\|\Delta u\|_{L^2}^2}{\|\nabla u\|_{L^2}^2} = \delta \tag{1.10}$$

and prove that, for every  $\delta > 0$ , this problem has a unique (up to shifts, scaling and alternation of sign) solution

$$u_\mu(x) = \sum_{k \in \mathbb{Z}^2 - \{0\}} \frac{e^{ik \cdot x}}{k^2(1 + \mu k^2)}, \quad k^2 := k_1^2 + k_2^2 \tag{1.11}$$

(compare with (1.4)) and the parameter  $\mu$  can be found, in a unique way, as a solution of

$$\frac{\|\Delta u_\mu\|_{L^2}^2}{\|\nabla u_\mu\|_{L^2}^2} = \delta. \tag{1.12}$$

Let us denote the maximum in (1.10) by  $\Theta(\delta)$ ; as we will see,  $\Theta$  is a real analytic function of  $\delta$ . Then,

$$\|u\|_{C(\mathbb{T}^2)}^2 \leq \|\nabla u\|_{L^2(\mathbb{T}^2)}^2 \Theta\left(\frac{\|\Delta u\|_{L^2(\mathbb{T}^2)}^2}{\|\nabla u\|_{L^2(\mathbb{T}^2)}^2}\right) \tag{1.13}$$

holds, and, by definition,  $\Theta$  is the least possible function in this inequality. Thus, (1.13) can be considered as an optimal version of (1.1) and (1.9). However, (1.13) is not convenient for applications, since the function  $\Theta$  is given in a very implicit form through lattice sums (1.11), which, to the best of our knowledge, cannot be expressed in closed form through the elementary functions (in contrast to the case of inequality (1.8) in a unit ball; see [3]) and, in addition, direct numerical computation of them is not easy, especially for large  $\delta$  (small  $\mu$ ), due to a very slow rate of convergence.

In order to overcome this problem, we have found the asymptotic expansions for the function  $\Theta(\delta)$  as  $\delta \rightarrow \infty$ . Namely, we have proved that the function  $\Theta(\delta)$  coincides, up to exponentially small terms (of order  $O(\exp(-2\pi\delta^{1/2}))$ ), with the function  $\Theta_0(\delta)$  given by the parametric expression

$$\Theta_0 = \frac{1}{4\pi^2} \cdot \frac{(\pi \log(1/\mu) + \beta + \mu)^2}{\pi \log(1/\mu) + \beta - \pi + 2\mu}, \quad \delta = \frac{\pi/\mu - 1}{\pi \log(1/\mu) + \beta - \pi + 2\mu}, \tag{1.14}$$

where  $\beta := \pi(2\gamma + 2 \log 2 + 3 \log \pi - 4 \log \Gamma(1/4))$ ,  $\gamma$  is the Euler constant and  $\Gamma(z)$  is the Euler gamma function. In particular,

$$\Theta_0(\delta) = \frac{1}{4\pi} \log \delta + \frac{1}{4\pi} \log \log \delta + \frac{\beta + \pi}{4\pi^2} + O_{\delta \rightarrow \infty}(1),$$

which justifies (1.9) and shows that the constant  $L \geq L_\infty := (\beta + \pi)/\pi$ . In practice, the numerics show that  $L \geq L_{\text{opt}} > L_\infty$ ; see §3.

In addition, combining the analytic asymptotic expansions for  $\Theta(\delta)$  with numerical simulation for relatively small  $\delta$ , we show that

$$\Theta(\delta) \leq \Theta_0(\delta) \tag{1.15}$$

for all  $\delta \geq 1$ . Thus, the much simpler function  $\Theta_0$  can be used instead of  $\Theta$  in the right-hand side of (1.13). Actually,  $\Theta_0$  gives a reasonable approximation to  $\Theta$  for all values of  $\delta$ . For instance, for  $\delta = 1, 2$  and  $4$ , respectively, we have  $\Theta = 0.10134, 0.26651$  and  $0.35112$  (respectively,  $\Theta_0 = 0.17797, 0.26660$  and  $0.35112$ ).

The paper has the following structure. The proof of the existence of the conditional extremals for (1.10), as well as analytical formulae for them in terms of the lattice sums, are given in §2.

The key asymptotic expansions for the lattice sums involving the parametric expression for  $\Theta(\delta)$ , as well as for the extremals  $u_\mu(x)$ , are presented in §3. Based on these expansions, we check the validity of (1.9), as well as estimate (1.15).

The alternative approaches to logarithmic inequality (1.1) are analysed in §4. Actually, there are at least two known ways to prove this inequality without studying the corresponding extremal problem. One of them is based on the embedding  $H^{1+\varepsilon} \subset C$ , with further optimization of the exponent  $\varepsilon > 0$  (see, for example, [2]), and the other, more classical one (which was used in the original paper [6]), splits the function  $u$  into lower and higher Fourier modes and estimates them via the  $H^1$ - and  $H^2$ -norms, respectively. Based on the above asymptotic analysis, we show that the second method is preferable and allows us to find the correct expressions for the two leading terms in the asymptotic expansions of the function  $\Theta$ .

The application of our approach to the simpler algebraic case (1.2), with  $l = 0$  and arbitrary space dimension  $d$ , is considered in §5. We establish the following improved version of (1.2):

$$\|u\|_{C(\mathbb{T}^d)}^2 \leq c_d(n) \|u\|_{L^2}^{2-d/n} \|(-\Delta_x)^{n/2} u\|_{L^2}^{d/n} - K_d(n) \|u\|_{L^2}^2, \tag{1.16}$$

where  $c_d(n) = c_{\mathbb{R}^d}(0, n)$  for all  $n \in \mathbb{N}$  such that  $2n - d > 0$  and the constant  $K_d(n)$  may be either positive or negative. We prove that, in the one-dimensional case, this constant is strictly positive, but it may be either positive or negative in the multi-dimensional case, depending on  $n$ . We also present combined analytical/numerical results for the constants  $K_d(n)$  for  $d$  and  $n$  not large. In particular, (1.5), (1.7) mentioned above, as well as the one-dimensional inequalities

$$\|u\|_{C(\mathbb{T}^1)}^2 \leq \|u\|_{L^2} \|u'\|_{L^2} - \frac{1}{\pi} \|u\|_{L^2}^2, \quad \|u\|_{C(\mathbb{T}^1)}^2 \leq \frac{\sqrt{2}}{\sqrt[4]{27}} \|u\|_{L^2}^{3/2} \|u''\|_{L^2}^{1/2} - \frac{2}{3\pi} \|u\|_{L^2}^2,$$

are verified therein.

The large  $n$  limit of (1.16) is studied in §6. The results of this section clarify the nature of oscillations in the analog of the function  $\delta \rightarrow \Theta(\delta)$  for that inequality and show the principal difference between the one-dimensional case, where regular oscillations occur (after the proper scaling), and the multi-dimensional case, where the oscillations are irregular due to some number-theoretic reasons.

Finally, the computation of the integration constant  $\beta$  is given in the appendix.

**2. Conditional extremals: existence, uniqueness and analytical expressions**

This section is devoted to the study of maximization problem (1.10), which we rewrite in the equivalent form

$$\|u\|_{C(\mathbb{T}^2)}^2 \rightarrow \sup, \quad u \in H^2(\mathbb{T}^2), \quad \int_{\mathbb{T}^2} u(x) \, dx = 0, \quad \|\Delta u\|_{L^2}^2 = \delta, \quad \|\nabla u\|_{L^2}^2 = 1. \tag{2.1}$$

In addition, we note that (2.1) is invariant with respect to translations  $u(x) \rightarrow u(x + h)$  and alternation  $u(x) \rightarrow -u(x)$ . Thus, without loss of generality, we may assume that  $\|u\|_{C(\mathbb{T}^2)} = u(0) > 0$ , and so reduce (2.1) to

$$u(0) \rightarrow \sup, \quad u \in H^2(\mathbb{T}^2), \quad \int_{\mathbb{T}^2} u(x) \, dx = 0, \quad \|\Delta u\|_{L^2}^2 = \delta, \quad \|\nabla u\|_{L^2}^2 = 1. \tag{2.2}$$

Thus, the function  $\Theta$  in (1.13) can be defined as

$$\Theta(\delta) := \sup \left\{ u(0)^2, \quad u \in H^2(\mathbb{T}^2), \quad \int_{\mathbb{T}^2} u(x) \, dx = 0, \quad \|\Delta u\|_{L^2}^2 = \delta, \quad \|\nabla u\|_{L^2}^2 = 1 \right\}. \tag{2.3}$$

It is, however, more convenient to rewrite (2.2) and (2.3) in Fourier space by expanding

$$u(x) = \frac{1}{2\pi} \sum' u_k e^{ix \cdot k}, \tag{2.4}$$

where  $\sum'$  means the sum over the lattice  $k \in \mathbb{Z}^2$ , excepting  $k = 0$ . Using the Parseval equality, we transform (2.2) to

$$\frac{1}{2\pi} \sum' u_k \rightarrow \sup, \quad \sum' (k^2)^2 |u_k|^2 = \delta, \quad \sum' k^2 |u_k|^2 = 1. \tag{2.5}$$

Finally, we observe that, without loss of generality, we may assume that all  $u_k$  in (2.5) are *real* and *non-negative*.

**LEMMA 2.1.** *For every  $\delta \geq 1$  there exists an extremal function (maximizer) for (2.2) (or, equivalently, for (2.5)).*

*Proof.* Let  $u_n(x)$ ,  $u_n(0) > 0$ , be a maximizing sequence for (2.2) such that

$$\Theta(\delta) = \lim_{n \rightarrow \infty} u_n(0)^2.$$

Such a sequence exists if and only if  $\delta \geq 1$ , since under that condition the set of functions  $u \in H^2(\mathbb{T}^2)$  for which the constraints of (2.2) are satisfied is not empty. Clearly,  $u_n$  is bounded in  $H^2$  and, consequently, without loss of generality, we may assume that  $u_n \rightarrow u_*$  weakly in  $H^2$  (and strongly in  $C(\mathbb{T}^2)$  and in  $H^1$ ). We claim that  $u_*$  is the desired maximizer. Clearly,

$$\Theta(\delta) = u_*(0)^2, \quad \|\nabla u_*\|_{L^2}^2 = 1, \quad \|\Delta u_*\|_{L^2}^2 \leq \delta. \tag{2.6}$$

Thus, we need only check that the last inequality is in fact an *equality*. Assume that it is not true and that  $\|\Delta_x u_*\|_{L^2}^2 = \delta_0 < \delta$ . We fix  $k_0 \in \mathbb{Z}^2$  such that  $u_{k_0} > 0$ , take

any small  $\varepsilon > 0$  and  $N > |k_0|$  and consider the perturbed function

$$u_{\varepsilon,N}(x) = u_*(x) - \beta e^{ik_0 \cdot x} + \varepsilon \sum_{|k_0| < k < N} \frac{e^{ik \cdot x}}{|k|^2 \log(|k| + 1)},$$

where  $\beta = \beta(\varepsilon, N) > 0$  is chosen in such way that  $\|\nabla u_{\varepsilon,N}\|_{L^2} = 1$ . Using the fact that

$$\sum' \frac{1}{|k|^2 \log^2(|k| + 1)} < \infty$$

and that  $u_{k_0} > 0$ , one can easily show that there exist positive constants  $\varepsilon_0$  and  $l$ , independent of  $N$ , such that

$$0 < \beta(\varepsilon, N) \leq l\varepsilon \quad \forall \varepsilon \leq \varepsilon_0 \tag{2.7}$$

and all  $N$ . On the other hand, using (2.7) and the fact that

$$\sum' \frac{1}{|k|^2 \log(|k| + 1)} = \infty,$$

we see that there exists  $N_0$ , independent of  $\varepsilon$ , such that

$$u_{\varepsilon,N}(0) > u_*(0) \quad \forall N \geq N_0, \varepsilon \leq \varepsilon_0. \tag{2.8}$$

Finally, since

$$\lim_{\varepsilon \rightarrow 0} \|\Delta_x u_{\varepsilon,N}\|_{L^2}^2 = \delta_0 < \delta, \quad \lim_{N \rightarrow \infty} \|\Delta_x u_{\varepsilon,N}\|_{L^2} = \infty,$$

we may find  $N_* > N_0$  and  $\varepsilon_* < \varepsilon_0$  such that  $\|\Delta_x u_{\varepsilon_*,N_*}\|_{L^2}^2 = \delta$ . This, together with (2.8), shows that

$$\Theta(\delta) > u_*(0)^2,$$

which contradicts our choice of function  $u_*(x)$  (see (2.6)) and completes the proof of the lemma.  $\square$

REMARK 2.2. In particular, the above arguments show that the function  $\delta \rightarrow \Theta(\delta)$  is strictly increasing.

We are now ready to state the main result of this section, which gives the existence and uniqueness for the extreme functions of (2.1). These functions will be referred to as *conditional extremals* for the critical Sobolev inequality considered.

THEOREM 2.3. *For every fixed  $\delta \geq 1$ , (1.10) has a unique (up to translations, scalings and alternation) solution*

$$u_\mu(x) := \sum' \frac{e^{ik \cdot x}}{k^2(1 + \mu k^2)}, \tag{2.9}$$

where  $\mu = \mu(\delta) \in (-\infty, -1] \cup (0, \infty]$  is determined as the unique solution of the equation

$$F(\mu) := \frac{\sum' 1/(1 + \mu k^2)^2}{\sum' 1/k^2(1 + \mu k^2)^2} = \delta. \tag{2.10}$$

Thus, the desired function  $\Theta(\delta)$  possesses the parametric representation

$$\Theta(\mu) := \frac{1}{4\pi^2} \frac{(\sum' 1/|k|^2(1 + \mu|k|^2))^2}{\sum' 1/|k|^2(1 + \mu|k|^2)^2}, \quad \delta(\mu) := \frac{\sum' 1/(1 + \mu k^2)^2}{\sum' 1/k^2(1 + \mu k^2)^2} \quad (2.11)$$

and  $\mu \in (-\infty, -1] \cup (0, \infty]$ .

REMARK 2.4. Being pedantic, (2.9) is well-defined for  $\mu \in (-\infty, -1) \cup (0, \infty)$  only and extra care is required for the limit cases  $\mu = -1$  and  $\mu = \infty$ . Indeed, in the case  $\mu = \infty$ , (2.9) formally gives the irrelevant value  $u_\mu(x) \equiv 0$  and, for  $\mu = -1$ , we have that  $u_\mu(x) = \infty$  (due to the poles at  $k = (\pm 1, 0)$  and  $k = (0, \pm 1)$ ). However, since the extremals  $u_\mu(x)$  are defined up to a scaling, we may retrieve the correct limit values of  $u_\mu$  at  $\mu = \infty$  and  $\mu = -1$  by the proper scaling. In particular, for  $\mu \rightarrow \infty$ , we need to use the scaling factor  $1/\mu$  in front of the right-hand side of (2.9), which gives that

$$u_\infty(x) := \sum' \frac{e^{ik \cdot x}}{|k|^4}, \quad \delta_\infty = \frac{\sum' 1/|k|^4}{\sum' 1/|k|^6}.$$

Thus, the singularity at  $\mu = \infty$  is removable and (as is not difficult to check) the function  $\delta \rightarrow \Theta(\delta)$  defined via (2.11) is *real analytic* near  $\delta = \delta_\infty$ . Analogously, using the scaling factor  $(1 + \mu)/2$  in (2.9) and passing to the limit  $\mu \rightarrow -1$ , we end up with

$$u_{-1}(x) = \cos x + \cos y, \quad \delta_{-1} = 1,$$

which is the correct extremal function for the limit case  $\delta = 1$ . Thus, the singularity at  $\mu = -1$  is again removable and the function  $\delta \rightarrow \Theta(\delta)$  is also *real analytic* near  $\delta = 1$ .

In contrast to that, the singularity near  $\mu \rightarrow 0+$  (which corresponds to the most interesting case, for us, of  $\delta \rightarrow \infty$ ) is *essential* and the majority of the paper is devoted to the study of various asymptotic expansions near  $\mu = 0$ .

*Proof of the theorem.* Instead of (1.10), we will consider the equivalent problem (2.5). The extremals of that problem can be easily found using Lagrange multipliers. Introducing the Lagrange function

$$\mathcal{L}(u) := \frac{1}{2\pi} \sum' u_k + A_1 \sum' |k|^2 u_k^2 + A_2 \sum' |k|^4 u_k^2, \quad A_1, A_2 \in \mathbb{R},$$

differentiating it with respect to  $u_k$  and using the necessary condition  $d(\mathcal{L}(u))/du = 0$  for extremals, we find that

$$u_k^* = u_{k, A_1, A_2}^* = \frac{1}{4\pi |k|^2 (A_1 + A_2 |k|^2)}, \quad (2.12)$$

where, as usual, the multipliers  $A_1$  and  $A_2$  should be chosen to satisfy the constraints. Since we already know (from lemma 2.1) that the maximizer  $u_\delta(x)$  exists, its Fourier coefficients should satisfy (2.12) for some  $A_1$  and  $A_2$ . Moreover, taking into account the fact that the initial variational problem is scaling invariant, we may get rid of one of the multipliers  $A_1$  and  $A_2$  by introducing  $\mu = A_2/A_1$ . We will then end up with the one-parameter family of extremals (2.9) depending on  $\mu$  (the case  $A_1 = 0$  is not lost and will correspond, in what follows, to  $\mu = \infty$ ). Of



course, the parameter  $\mu$  should be chosen to satisfy the constraints, namely, that  $\|\Delta u_\mu\|_{L^2}^2/\|\nabla u_\mu\|_{L^2}^2 = \delta$ . This gives (2.10), and (2.11) follows immediately from the definition of  $\Theta(\delta)$ .

Thus, we need only verify that the solution of  $F(\mu) = \delta$  is unique. To this end, we first recall that all the Fourier coefficients of the conditional maximizer(s) should be either non-negative or non-positive. This, together with (2.9), gives the conditions that  $\mu \in (-\infty, -1]$ , which corresponds to all negative coefficients, and  $\mu \in (0, \infty]$ , which corresponds to all positive ones. Thus, only the values  $\mu \in (-\infty, -1] \cup (0, \infty)$  may correspond to the true maximizers and we need not consider the case  $\mu \in (-1, 0)$ . The following lemma gives the uniqueness of a solution of (2.10) in this domain of  $\mu$ .

LEMMA 2.5. *Let  $\varepsilon := 1/\mu$ . Then, the function  $\tilde{F}(\varepsilon) := F(\varepsilon^{-1})$  is continuous (in fact, real analytic), strictly increasing on  $[-1, \infty)$  and satisfies*

$$\tilde{F}(-1) = 1, \quad \lim_{\varepsilon \rightarrow +\infty} \tilde{F}(\varepsilon) = +\infty. \tag{2.13}$$

Therefore, the solution of  $F(\mu) = \delta$ ,  $\mu \in (-\infty, -1] \cup (0, \infty)$ , exists and is unique for all  $\delta \geq 1$ .

*Proof.* The function  $\tilde{F}(\varepsilon)$  is

$$\tilde{F}(\varepsilon) = \frac{\sum' 1/(\varepsilon + |k|^2)^2}{\sum' 1/|k|^2(\varepsilon + |k|^2)^2}$$

and, differentiating this with respect to  $\varepsilon$ , we have that

$$\begin{aligned} \tilde{F}'(\varepsilon) &= -2 \frac{\sum'_k \sum'_l 1/l^2(\varepsilon + k^2)^2(\varepsilon + l^2)^2(1/(\varepsilon + k^2) - 1/(\varepsilon + l^2))}{(\sum' 1/|k|^2(\varepsilon + |k|^2)^2)^2} \\ &= 2 \frac{\sum'_k \sum'_l (1/(\varepsilon + k^2)^3(\varepsilon + l^2)^3)((k^2 - l^2)/l^2)}{(\sum' 1/|k|^2(\varepsilon + |k|^2)^2)^2}. \end{aligned}$$

The double-double sum in the numerator can be rearranged to contain only positive terms. Indeed, putting together the terms corresponding to the indices  $(l, k)$  and  $(k, l)$ , we see that

$$\frac{1}{(\varepsilon + k^2)^3(\varepsilon + l^2)^3} \left( \frac{k^2 - l^2}{l^2} + \frac{l^2 - k^2}{k^2} \right) = \frac{(k^2 - l^2)^2}{k^2 l^2 (\varepsilon + k^2)^3 (\varepsilon + l^2)^3} > 0.$$

Thus, we need only verify (2.13). The first assertion is obvious since both numerator and denominator in the definition of  $\tilde{F}$  have simple poles at  $\varepsilon = -1$  with the same residue. The second limit is a bit more difficult, but we do not want to prove it here since the detailed analysis of the asymptotic behaviour of  $F$  as  $\mu \rightarrow 0$  will be given in the next section. Lemma 2.5 is proved.  $\square$

Thus, due to the proven uniqueness of a solution of (2.10), the conditional maximizer  $u_\mu(x) = u_{\mu(\delta)}(x)$  for variational problem (1.10) is also unique and theorem 2.3 is proved.  $\square$

REMARK 2.6. One can see that the extremals  $u_\mu(x)$  defined by (2.9) satisfy the boundary-value problem

$$\Delta_x(1 - \mu\Delta_x)u_\mu = -4\pi^2\delta(x) + 1 \tag{2.14}$$

endowed with periodic boundary conditions (here  $\delta(x)$  is a standard Dirac delta-function) and, therefore, are closely related to fundamental solutions for this family of fourth-order elliptic differential operators. It can also be derived by applying the method of Lagrange multipliers directly to (2.2) (without passing to Fourier space). We will use this fact in the following, in order to find good asymptotic expansions for  $u_\mu(x)$ .

### 3. Asymptotic expansions

In this section, we deduce the asymptotic expansions up to exponential order for the lattice sums used in theorem 2.3, which are crucial for our approach. Namely, we will analyse the asymptotic behaviour of

$$\left. \begin{aligned} f(\mu) &= \sum' \frac{1}{k^2(1 + \mu k^2)}, \\ g(\mu) &= \sum' \frac{1}{k^2(1 + \mu k^2)^2}, \\ h(\mu) &= \sum' \frac{1}{(1 + \mu k^2)^2} \end{aligned} \right\} \tag{3.1}$$

as  $\mu \rightarrow 0$ . Actually, these sums are closely related to each other as

$$f'(\mu) = -h(\mu), \quad g(\mu) = f(\mu) - \mu h(\mu) \tag{3.2}$$

and, therefore, up to a non-trivial integration constant, we need only study the simplest function,  $h(\mu)$ .

LEMMA 3.1. *The function  $h(\mu)$  possesses the asymptotic expansion*

$$h(\mu) = \frac{\pi}{\mu} - 1 + 4\pi^2\mu^{-5/4}e^{-2\pi/\sqrt{\mu}}(1 + o_\mu(1)) \tag{3.3}$$

as  $\mu \rightarrow 0+$ .

*Proof.* The derivation of the expansion is based on the Poisson summation formula. Using the fact that

$$\sum_{k \in \mathbb{Z}^2} \varphi_\mu(k) = \sum_{k \in \mathbb{Z}^2} \widehat{\varphi}_\mu(2\pi k), \quad \varphi_\mu(z) = \frac{1}{(1 + \mu z^2)^2}, \tag{3.4}$$

$\varphi_\mu(z) = \varphi_1(\mu^{1/2}z)$  and  $\widehat{\varphi}_\mu(\xi) = \mu^{-1}\widehat{\varphi}_1(\mu^{-1/2}\xi)$  together with the fact that  $\varphi_1$  is analytic in a strip  $|\operatorname{Im} z| < 1$ , we conclude that  $\widehat{\varphi}_1(\xi)$  is exponentially decaying, i.e.

$$|\widehat{\varphi}_1(\xi)| \leq C_\varepsilon e^{-(1-\varepsilon)|\xi|} \quad \forall \varepsilon > 0, \quad \xi \in \mathbb{R}^2.$$

Thus, if we need the asymptotic expansion of the left-hand side of (3.4) up to exponential order, only the term with  $k = 0$  is needed in the right-hand side and,

therefore, replacing the sum by the corresponding integral gives an exponentially sharp approximation to the lattice sum:

$$\begin{aligned} h(\mu) &= \sum' \frac{1}{(1 + \mu k^2)^2} = \sum_{k \in \mathbb{Z}^2} \varphi_\mu(k) - 1 \\ &= \int_{\mathbb{R}^2} \frac{dx}{(1 + \mu|x|^2)^2} - 1 + o(e^{(-2+\varepsilon)\pi\mu^{-1/2}}) \\ &= \frac{\pi}{\mu} - 1 + o(e^{(-2+\varepsilon)\pi\mu^{-1/2}}) \end{aligned} \tag{3.5}$$

for arbitrary (small)  $\varepsilon > 0$ . However, if we need the leading exponentially small term in expansions like (3.3), we need to look at four more terms on the right-hand side of (3.4), namely, the terms corresponding to  $k = (0, 1), (0, -1), (1, 0), (-1, 0)$  (other terms will decay faster than  $\exp((-2+\varepsilon)\sqrt{2}\pi/\mu^{1/2})$ ). To this end, we need to compute the two-dimensional Fourier transform of the radially symmetric function  $\varphi_\mu(|x|)$ . This can be done, for instance, by noting that the Fourier transform is a radially symmetric fundamental solution of the squared Helmholtz operator

$$(1 - \mu\Delta_x)^2 u = \delta(x).$$

The radially symmetric solution of this equation can be explicitly written in terms of Bessel functions as

$$R(|\xi|) := \hat{\varphi}_1(\xi) = \pi|\xi|\mu^{-3/2}K_1(|\xi|/\sqrt{\mu}), \tag{3.6}$$

where  $K_1$  is the standard Bessel  $K$ -function of order 1 (see, for example, [33]). Thus, we need only find the leading term in  $R(2\pi\mu^{-1/2})$  as  $\mu \rightarrow 0+$ , which can be done by using known expansions for the Bessel functions (see [33]):

$$R(2\pi\mu^{-1/2}) = \pi^2\mu^{-5/4}e^{-2\pi/\sqrt{\mu}}(1 + o_\mu(1)).$$

Taking into account the fact that there are four identical terms on the right-hand side of (3.4), which correspond to  $|k| = 1$ , we arrive at (3.3) and finish the proof of the lemma.  $\square$

As a next step, we derive analogous expansions for  $f(\mu)$  and  $g(\mu)$ . However, the trick with the Poisson summation formula is not directly applicable here since the corresponding function  $\varphi$  will have singularity at  $x = 0$  and, as we will see below, this leads to an extra residual-type term in the expansions. Instead, we will use relations (3.2) in order to find the expansions for  $f$  and  $g$  up to an integration constant.

**COROLLARY 3.2.** *The functions  $f(\mu)$  and  $g(\mu)$  possess the asymptotic expansions*

$$f(\mu) = \pi \log \frac{1}{\mu} + \mu + \beta - 4\pi\mu^{1/4}e^{-2\pi/\sqrt{\mu}}(1 + o_\mu(1)) \tag{3.7}$$

and

$$g(\mu) = \pi \log \frac{1}{\mu} + 2\mu + \beta - \pi - 4\pi^2\mu^{-1/4}e^{-2\pi/\sqrt{\mu}}(1 + o_\mu(1)) \tag{3.8}$$

as  $\mu \rightarrow 0$ , where the integration constant  $\beta = \pi(2\gamma + 2 \log 2 + 3 \log \pi - 4 \log \Gamma(1/4))$ .

*Proof.* Up to the integration constant  $\beta$ , expansions (3.7) and (3.8) are straightforward corollaries of (3.3) and (3.2), so we only mention here the explicit expression for the integral of the leading exponential term in (3.3) with respect to  $\mu$ ,

$$\int_{\mu}^{\infty} 4\pi^2 x^{-5/4} e^{-2\pi/\sqrt{x}} dx = 4\pi^2 \sqrt{2} \operatorname{erf}(\sqrt{2\pi} \mu^{-1/4}),$$

where  $\operatorname{erf}(x)$  is the usual probability integral. Then, using the well-known expansions for  $\operatorname{erf}(z)$  near  $z = \infty$ , we find the leading exponential term in (3.7) (and (3.8) follows immediately from the second formula of (3.2)).

Thus, we need only find the integration constant  $\beta$ . This, however, is a much more delicate problem and the arguments above do not indicate how to compute it. The derivation, based on the Hardy formula for the two-dimensional analogue of the Riemann zeta function, is given in the appendix. Corollary 3.2 is proved.  $\square$

**COROLLARY 3.3.** *Let the functions  $\Theta(\delta)$  and  $\Theta_0(\delta)$  be defined via (2.3) and (1.14), respectively. Then,*

$$\Theta(\delta) = \Theta_0(\delta) + o(e^{-(2-\varepsilon)\pi\delta^{1/2}}) \tag{3.9}$$

as  $\delta \rightarrow \infty$  (here  $\varepsilon > 0$  is arbitrary).

Indeed, (3.9) follows in a straightforward way from theorem 2.3 and (3.3), (3.7) and (3.8) (even without the leading exponentially small terms).

We now check that  $\Theta_0(\delta)$  is always *larger* than  $\Theta(\delta)$ . We start by checking this property for large  $\delta$ .

**LEMMA 3.4.** *There exists  $\delta_0 > 0$  such that*

$$\Theta(\delta) \leq \Theta_0(\delta) \tag{3.10}$$

for all  $\delta > \delta_0$ .

*Proof.* We introduce the following exponentially corrected analogue of the function  $\Theta_0$ :

$$\left. \begin{aligned} \Theta_{\text{exp}}(\mu) &= \frac{1}{4\pi^2} \frac{(\pi \log(1/\mu) + \beta + \mu - 4\pi\mu^{1/4}e^{-2\pi/\sqrt{\mu}})^2}{\pi \log(1/\mu) + \beta - \pi + 2\mu - 4\pi^2\mu^{-1/4}e^{-2\pi/\sqrt{\mu}}}, \\ \delta(\mu) &= \frac{\pi/\mu - 1 + 4\pi^2\mu^{-5/4}e^{-2\pi/\sqrt{\mu}}}{\pi \log(1/\mu) + \beta - \pi + 2\mu - 4\pi^2\mu^{-1/4}e^{-2\pi/\sqrt{\mu}}}. \end{aligned} \right\} \tag{3.11}$$

Then, according to (3.3), (3.7) and (3.8), the function  $\Theta_{\text{exp}}(\delta)$  gives a *better* approximation to  $\Theta(\delta)$  than  $\Theta_0(\delta)$  if  $\delta$  is large. Consequently, to prove the lemma, it is sufficient to verify that

$$\Theta_{\text{exp}}(\delta) \leq \Theta_0(\delta) \tag{3.12}$$

for large  $\delta$ . To this end, we introduce small  $\varepsilon := 4\pi\mu^{-1/4}e^{-2\pi/\sqrt{\mu}}$  and write (3.11) in the form

$$\left. \begin{aligned} \Theta(\mu, \varepsilon) &= \frac{1}{4\pi^2} \frac{(\pi \log(1/\mu) + \beta + \mu - \mu^{1/2}\varepsilon)^2}{\pi \log(1/\mu) + \beta - \pi + 2\mu - \pi\varepsilon}, \\ \delta(\mu, \varepsilon) &= \frac{\pi/\mu - 1 + \pi\mu^{-1}\varepsilon}{\pi \log(1/\mu) + \beta - \pi + 2\mu - \pi\varepsilon}. \end{aligned} \right\} \tag{3.13}$$

Then, since  $\varepsilon$  is extremely small in comparison with  $\mu$  if  $\mu$  is small, we may consider it as an infinitesimal increment. Therefore, (3.12) will be satisfied if and only if the infinitesimal shift along the vector  $(\partial_\varepsilon\delta, \partial_\varepsilon\Theta)|_{\varepsilon=0}$  lies *under* the tangent line to  $(\delta(\mu, 0), \Theta(\mu, 0))$ . This requires us to verify the condition that

$$(\partial_\mu\Theta\partial_\varepsilon\delta - \partial_\varepsilon\Theta\partial_\mu\delta)|_{\varepsilon=0} < 0.$$

Direct calculation gives that

$$\begin{aligned} & (\partial_\mu\Theta\partial_\varepsilon\delta - \partial_\varepsilon\Theta\partial_\mu\delta)|_{\varepsilon=0} \\ &= -\frac{1}{2\pi^2} \frac{(\pi \log(1/\mu) + \beta + \mu)(\pi^2 \log(1/\mu) + \pi\beta - 2\pi^2 + 5\pi\mu - 2\mu^2)}{\mu^{3/2}(\pi \log(1/\mu) + \beta - \pi + 2\mu)^3} \end{aligned}$$

and we see that the right-hand side is indeed negative if  $\mu$  is small enough. Thus, lemma 3.4 is proved.  $\square$

Thus, the desired inequality (3.9) is analytically verified for large  $\delta$ . In contrast, it is unlikely that it can be analogously checked for small values of  $\delta$  since the asymptotic expansions do not work here and we need to work directly with the lattice sums. However, the *numerics* are reliable for  $\delta$  ‘not large’, so instead we check it numerically in that region. As follows from our numerical simulations, the conjecture is indeed true for all values of  $\delta \geq 1$ . Thus, we have verified the validity of the improved version of the critical Sobolev inequality

$$\|u\|_{C(\mathbb{T}^2)}^2 \leq \|\nabla u\|_{L^2(\mathbb{T}^2)}^2 \Theta_0 \left( \frac{\|\Delta u\|_{L^2(\mathbb{T}^2)}^2}{\|\nabla u\|_{L^2(\mathbb{T}^2)}^2} \right) \tag{3.14}$$

for all  $2\pi \times 2\pi$ -periodic functions with zero mean.

REMARK 3.5. As we have already mentioned, the value of  $\Theta(\delta)$  is extremely close to  $\Theta_0(\delta)$ , even for relatively small  $\delta$  (e.g. for  $\delta = 4$  the difference is already less than  $10^{-5}$ ), so the high precision computations of the lattice sums (3.1) are required in order to show that  $\Theta$  is indeed smaller than  $\Theta_0$ . Since direct computation of these sums includes many terms, this method is rather slow. Alternatively, using the Poisson summation formula, we have that

$$h(\mu) = \frac{\pi}{\mu} - 1 + 2\pi^2 \mu^{-3/2} \sum' |k| K_1(2\pi\mu^{-1/2}|k|)$$

and, integrating this over  $\mu$  and keeping in mind the value of the integration constant, we arrive at

$$f(\mu) = \pi \log \frac{1}{\mu} + \beta + \mu - 8\pi \sum' K_0(2\pi\mu^{-1/2}|k|), \quad g(\mu) = f(\mu) - \mu h(\mu).$$

Since the Bessel functions  $K_0(x)$  and  $K_1(x)$  decay exponentially as  $|x| \rightarrow \infty$ , the transformed series converge much faster and appear preferable for the high precision computations. Actually, we use both approaches in order to double check our numerics.

Our next task is to present a rougher version of (3.14), approximating the right-hand side of (3.14) by simpler functions. To this end, we need the following lemma.

LEMMA 3.6. *The function  $\Theta(\delta)$  possesses the asymptotic expansion*

$$\Theta(\delta) = \frac{1}{4\pi} \left( \log \delta + \log \log \delta + \frac{\beta + \pi}{\pi} + \frac{\log \log \delta}{\log \delta} + O((\log \delta)^{-1}) \right) \tag{3.15}$$

as  $\delta \rightarrow \infty$ .

*Proof.* We first note that, since  $\Theta(\delta)$  is exponentially close to  $\Theta_0(\delta)$ , we may verify (3.15) for the function  $\Theta_0$  only. To this end, we need to find the expansion for  $\mu = \mu(\delta)$  ( $\delta \gg 1$ , which corresponds to  $\mu \ll 1$ ) from

$$\delta = \frac{\pi/\mu - 1}{\pi \log(1/\mu) + \beta - \pi + 2\mu}$$

and insert it into the expression for  $\Theta_0(\mu)$ . To compute the expansion for  $\mu(\delta)$ , we drop the term  $2\mu$  in the denominator (which only leads to an error of order  $O(\delta^{-1+\varepsilon})$ ,  $\varepsilon > 0$ , in the final answer). Then, the equation obtained,

$$\frac{\pi/\mu - 1}{\pi \log(1/\mu) + \beta - \pi + 2\mu} = \delta,$$

can be solved explicitly in terms of the so-called Lambert W function

$$\frac{1}{\mu} = -\delta W_{-1} \left( -\delta^{-1} \exp \left( -\frac{1 + \delta(\beta - \pi)}{\pi\delta} \right) \right), \tag{3.16}$$

where  $W_{-1}$  is the  $-1$ -branch of the Lambert function (see [11] for details). We also note that

$$\Theta_0(\mu) = \frac{1}{4\pi} \log \frac{1}{\mu} + \frac{\beta + \pi}{4\pi^2} + O \left( \left( \log \frac{1}{\mu} \right)^{-1} \right) \tag{3.17}$$

and, therefore, the remainder is again non-essential for (3.15) and can be dropped. Thus, it remains only to expand the logarithm of the right-hand side of (3.16). To this end, we use the expansion (see [11]) for the Lambert function  $W_{-1}$  near zero:

$$W_{-1}(-z) = \log z - \log(-\log z) + O \left( \frac{\log(-\log z)}{\log(-z)} \right), \quad z \rightarrow 0-. \tag{3.18}$$

This gives that

$$\frac{1}{\mu} = \delta \log \delta + \delta(\pi - \beta) - \frac{1}{\pi} + \delta \log \left( \log \delta + \pi - \beta - \frac{1}{\pi\delta} \right) + O \left( \frac{\log \log \delta}{\log \delta} \right).$$

Taking the logarithm of the right-hand side of this formula, inserting the result in (3.17) and dropping the lower-order terms, we end up with (3.15) and complete the proof of the lemma.  $\square$

We are now ready to state the improved critical Sobolev inequality with double-logarithmic correction.

THEOREM 3.7. *The inequality*

$$\|u\|_{C(\mathbb{T}^2)}^2 \leq \frac{1}{4\pi} \|\nabla u\|_{L^2(\mathbb{T}^2)}^2 \left( \log \frac{\|\Delta u\|_{L^2(\mathbb{T}^2)}^2}{\|\nabla u\|_{L^2(\mathbb{T}^2)}^2} + \log \left( 1 + \log \frac{\|\Delta u\|_{L^2(\mathbb{T}^2)}^2}{\|\nabla u\|_{L^2(\mathbb{T}^2)}^2} \right) + L \right) \tag{3.19}$$

holds for all  $2\pi \times 2\pi$ -periodic functions  $u$  with zero mean. The constant  $L > \beta + \pi/\pi$  is defined as

$$L := \max_{\delta \geq 1} \{4\pi\Theta(\delta) - (\log \delta + \log(1 + \log \delta))\}. \tag{3.20}$$

This maximum is achieved at some finite  $1 < \delta_* < \infty$  and the corresponding conditional extremal  $u_{\mu(\delta_*)}(x)$  is an exact extremal function for (3.19).

*Proof.* In the light of the asymptotic expansion (3.15) and the fact that  $\Theta(\delta)$  is continuous, the supremum over  $\delta \geq 1$  of the function on the right-hand side of (3.20) is finite. Moreover, since the first decaying term in that expansion ( $\log \log \delta / \log \delta$ ) is positive, the inequality cannot hold with  $L = (\beta + \pi)/\pi$ . In fact, there is an extra ‘1’ in the double-logarithmic term in (3.19) in comparison with (3.15), introduced in order that the right-hand side be a well-defined function for all  $\delta \geq 1$ . However, this term is only an  $O((\log \delta)^{-1})$  correction, which is weaker than the first decaying term in the expansions (3.15) and cannot change anything.

Thus, the above supremum cannot be achieved as  $\delta \rightarrow \infty$  and, therefore, since  $\Theta(\delta)$  is continuous, it is achieved at some finite point  $\delta = \delta_*$  and must be larger than the value at infinity ( $L > (\beta + \pi)/\pi \sim 1.82283$ ). Then, by the definition of  $\Theta$  and  $L$ , (3.19) holds and equality is achieved on the function  $u(x) = u_{\mu(\delta_*)}(x)$ . Theorem 3.7 is proved.  $\square$

According to our numerical analysis, the maximum in (3.20) is *unique* and is achieved at  $\delta_* \sim 3.92888$ , which corresponds to  $L \sim 2.15627$ . Thus, the exact extremum function  $u_{\mu(\delta_*)}(x)$  is also *unique* up to translations, scaling and alternation.

We conclude this section by analysing the structure of the extremal functions  $u_\mu(x)$  for small, positive  $\mu$  (corresponding to large  $\delta$ ).

LEMMA 3.8. *The extremals  $u_\mu(x)$  possess the expansions*

$$u_\mu(x) = -2\pi K_0(\mu^{-1/2}|x|) + G_0(x) + \mu + C_\mu + V_\mu(x), \tag{3.21}$$

where  $G_0(x)$  is a fundamental solution of the Laplacian

$$\Delta_x G_0 = -4\pi^2 \delta(x) + 1, \quad \partial_n G_0|_{\partial([- \pi, \pi]^2)} = 0, \quad \int_{\mathbb{T}^2} G_0(x) \, dx = 0, \tag{3.22}$$

$K_0$  is the zero-order Bessel  $K$  function,

$$C_\mu := -\frac{\mu}{2\pi} \int_{\mathbb{R}^2 \setminus \mu^{-1/2}[- \pi, \pi]^2} K_0(x) \, dx$$

is an exponentially small (with respect to  $\mu \rightarrow 0+$ ) constant and the exponentially small function  $V_\mu(x)$  solves the following fourth-order elliptic equation in  $T = [-\pi, \pi]^2$  with non-homogeneous boundary conditions:

$$\left. \begin{aligned} \Delta(1 - \mu\Delta)V_\mu &= 0, & \partial_n V_\mu|_{\partial T} &= 2\pi\partial_n K_0(\mu^{-1/2}|x|)|_{\partial_n T}, \\ \partial_n \Delta_x V_\mu|_{\partial T} &= 2\pi\partial_n \Delta_x K_0(\mu^{-1/2}|x|)|_{\partial_n T}, & \int_{\mathbb{T}^2} V_\mu(x) \, dx &= 0. \end{aligned} \right\} \tag{3.23}$$

*Proof.* According to remark 2.6, the function  $V_\mu(x)$  solves the fourth-order elliptic equation (2.14) with periodic boundary conditions. Moreover, owing to the symmetry, the periodic boundary conditions can be replaced by homogeneous Neumann ones. Now, let  $G_0$  be the fundamental solution of the Laplacian in a square defined by (3.22) (the solution of this equation exists since the right-hand side has zero mean). Then, using the fact that

$$(1 - \mu\Delta_x)K_0(\mu^{-1/2}|x|) = +2\pi\mu\delta(x) \quad (3.24)$$

we end up with

$$\Delta_x(1 - \Delta_x)[2\pi K_0(\mu^{-1/2}|x|) + G_0(x)] = -4\pi^2\delta(x) + 1$$

and, therefore, using also the obvious fact that  $\partial_n \Delta_x G_0(x)|_{\partial T} = 0$ , we see that the remainder  $V_\mu$  should indeed satisfy (3.23). The solvability condition

$$(1 - \mu\Delta_x)K_0(\mu^{-1/2}|x|)|_{\partial T} = 0$$

for that equation is satisfied in the light of (3.24). Thus, decomposition (3.21) is verified up to a constant (we recall that the function  $u_\mu(x)$  must have zero mean). In order to find this constant we note that, by definition, the functions  $G_0(x)$  and  $V_\mu(x)$  have zero means, so only the function  $K_0$  has non-zero mean and, hence, the constant is determined by

$$\begin{aligned} C &= \frac{1}{2\pi} \int_{\mathbb{T}^2} K_0(\mu^{-1/2}|x|) \, dx \\ &= -\frac{\mu}{2\pi} \int_{\mu^{-1/2}\mathbb{T}^2} K_0(|x|) \, dx \\ &= \frac{\mu}{2\pi} \left( \int_{\mathbb{R}^2} K_0(|x|) \, dx - \int_{\mathbb{R}^2 \setminus \mu^{-1/2}T} K_0(|x|) \, dx \right) \\ &= \mu + C_\mu. \end{aligned}$$

The constant  $C_\mu$  is indeed exponentially small as  $\mu \rightarrow 0+$  since the function  $K_0(z)$  is exponentially decaying as  $z \rightarrow \infty$ .  $\square$

Recall that

$$G_0(x) = 2\pi \log \frac{1}{|x|} + \text{'smooth remainder'};$$

therefore, the leading term of  $u_\mu(x)$  up to smooth zero-order terms in  $\mu$  is radially symmetric and is given by

$$u_\mu(x) = 2\pi \left( \log \frac{1}{|x|} - K_0(\mu^{-1/2}|x|) \right) + \text{'smooth, order zero remainder'}. \quad (3.25)$$

Thus,  $u_\mu(x)$  consists of a radially symmetric spike near  $x = 0$  corrected by lower-order terms. Figure 1 shows a contour plot of  $u_\mu(x)$  for  $\mu \approx 0.12211$ , which corresponds to  $\delta = \delta_*$  (see theorem 3.7).



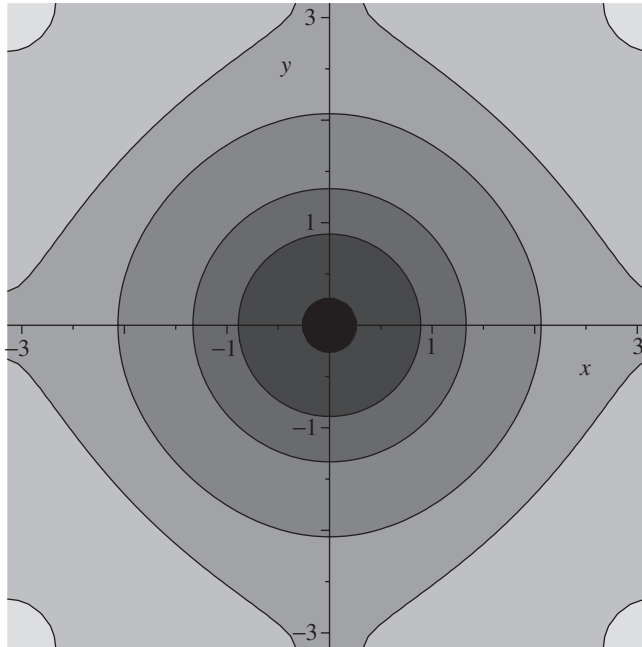

Figure 1. A contour plot of  $u_\mu(x, y)$  for  $\delta = \delta_* \approx 3.92888$  ( $\mu \approx 0.12211$ ). Darker areas are higher. The spike becomes almost perfectly radially symmetric, even for this relatively small value of  $\delta$ .

REMARK 3.9. Passing to the limit  $\mu \rightarrow 0$  (for  $|x| \neq 0$ ) in (3.22) and using lattice sum formula (1.11) for the extremals, we see that (at least formally)

$$G_0(x) = \sum' \frac{e^{ik \cdot x}}{k^2}. \tag{3.26}$$

It can be shown that the sign-alternating sum on the right-hand side is convergent (if the proper order of summation is chosen) for every  $x \neq 0$ , and the equality holds; see [4, 14]. In addition, using the known asymptotic expansion for the Bessel K-function near zero

$$K_0(z) = -\log z + \log 2 - \gamma + O(z^2),$$

see [33], together with (3.21) and (3.7), one can show that the integration constant  $\beta$  can be expressed in terms of  $G_0$  as

$$\begin{aligned} \beta &= 2\pi\gamma - 2\pi \log 2 + \lim_{x \rightarrow 0} \left( G_0(x) - 2\pi \log \frac{1}{|x|} \right) \\ &= 2\pi(\gamma - \log 2) + \lim_{x \rightarrow 0} \left( \sum' \frac{e^{ik \cdot x}}{k^2} - 2\pi \log \frac{1}{|x|} \right). \end{aligned} \tag{3.27}$$

Recall also that the fundamental solution  $G_0(x)$  can be explicitly written in terms of integrals of some elliptic functions (e.g. using the bi-conformal map between the square and the unit circle) and the values of  $G_0(x)$  can be explicitly found for some

$x$  by using identities for elliptic functions. For instance,

$$G_0((\pi, \pi)) = \sum_{(k_1, k_2) \in \mathbb{Z}^2 - \{0\}} \frac{(-1)^{k_1+k_2}}{k_1^2 + k_2^2} = -\pi \log 2;$$

see [13, 14]. However, we have failed to find limit (3.27) in this way, so our computation of the integration constant  $\beta$  (see the appendix) will be based on different arguments.

**4. Alternative approaches to the critical Sobolev inequality**

In this section, we discuss the possibility of obtaining (3.19) with *sharp* constant  $1/4\pi$  (at least in the leading term  $\log \delta$ ) using the standard strategies for proving the critical Sobolev inequality. In fact, we will analyse two such strategies. The first is based on the embedding of  $H^{1+\varepsilon}$  to  $C$  for every  $\varepsilon > 0$ ,

$$\|u\|_{C(\mathbb{T}^2)}^2 \leq \frac{C}{\varepsilon} \|u\|_{H^{1+\varepsilon}}^2, \tag{4.1}$$

where  $C$  is independent of  $\varepsilon \rightarrow 0$ , the interpolation  $\|u\|_{H^{1+\varepsilon}} \leq C \|u\|_{H^1}^{1-\varepsilon} \|u\|_{H^2}^\varepsilon$  and the proper choice of  $\varepsilon$  ( $\varepsilon \sim (\log \delta)^{-1}$ ).

The second strategy consists of splitting the function  $u$  into lower and higher Fourier modes,

$$u(x) = \sum' u_k e^{ik \cdot x} = \sum'_{|k| \leq N} u_k e^{ik \cdot x} + \sum'_{|k| > N} u_k e^{ik \cdot x}, \tag{4.2}$$

with a properly chosen  $N \sim \delta$ , and estimating the lower and higher Fourier modes using the  $H^1$ - and  $H^2$ -norms, respectively.

As we will see, the first scheme is *rough* and can give only the  $e$ -times larger constant  $e/4\pi$  in the leading term (even if the best constants in the intermediate inequalities are chosen). By contrast, the second scheme is much sharper and allows correct retrieval not only of the leading term, but also of the double-logarithmic correction.

We start with the first approach (following [2]). To proceed, we first need the sharp constant in  $L^\infty$ -embedding (4.1).

LEMMA 4.1. *Let  $\varepsilon > 0$  be arbitrary. Then, for every  $u \in H^{1+\varepsilon}(\mathbb{T}^2)$  with zero mean, the following inequality holds:*

$$\|u\|_{C(\mathbb{T}^2)}^2 \leq C(\varepsilon) \|(-\Delta_x)^{(1+\varepsilon)/2} u\|_{L^2(\mathbb{T}^2)}^2, \quad C(\varepsilon) := \frac{1}{4\pi^2} \sum' \frac{1}{|k|^{2(1+\varepsilon)}}. \tag{4.3}$$

The constant  $C(\varepsilon) = 1/4\pi\varepsilon + O_{\varepsilon \rightarrow 0}(1)$  is sharp and the exact extremals are given by

$$U_\varepsilon(x) := \sum' \frac{e^{ik \cdot x}}{|k|^{2(1+\varepsilon)}} \tag{4.4}$$

(up to scalings and shifts).

*Proof.* Indeed,

$$\begin{aligned} \|u\|_{C(\mathbb{T}^2)}^2 &\leq \frac{1}{4\pi^2} \left( \sum' |u_k| \right)^2 \\ &= \frac{1}{4\pi^2} \left( \frac{1}{|k|^{1+\varepsilon}} \cdot (|k|^{1+\varepsilon} |u_k|) \right)^2 \\ &\leq \frac{1}{4\pi^2} \sum' \frac{1}{|k|^{2(1+\varepsilon)}} \sum' |k|^{2(1+\varepsilon)} |u_k|^2 \\ &= C(\varepsilon) \|(-\Delta)^{(1+\varepsilon)/2} u\|_{L^2}^2 \end{aligned}$$

and the equalities here hold if  $u_k = C/|k|^{2(1+\varepsilon)}$ , which gives (4.4).

The leading term in the asymptotic expansions of  $C(\varepsilon)$  can easily be found, say, by replacing the sum with the corresponding integrals (see lemma A.1 in the appendix).  $\square$

REMARK 4.2. The lattice sum for  $C(\varepsilon)$  can be computed in a closed form through the Riemann zeta and Dirichlet beta functions using the Hardy formula

$$\sum' \frac{1}{|k|^{2(1+\varepsilon)}} = 4\zeta(1+\varepsilon)\beta(1+\varepsilon), \quad \beta(z) := \sum_{n=0}^{\infty} \frac{(-1)^n}{(2n+1)^z}; \quad (4.5)$$

see [35]. This formula, together with the asymptotic expansions of  $\zeta(1+\varepsilon)$  and  $\beta(1+\varepsilon)$ , will be required in the appendix in order to compute the integration constant  $\beta$ .

We now recall that the sharp constant in the interpolation inequality

$$\|(-\Delta)^{(1+\varepsilon)/2} u\|_{L^2} \leq \|\nabla u\|_{L^2}^{1-\varepsilon} \|\Delta_x u\|_{L^2}^{\varepsilon} \quad (4.6)$$

is unity and the exact extremals are the eigenfunctions of the Laplacian

$$U_k(x) = e^{ik \cdot x}, \quad k \in \mathbb{Z}^2 - \{0\}; \quad (4.7)$$

see [31] for the details. Thus, combining (4.3) and (4.6), we may write that

$$\begin{aligned} \|u\|_{C(\mathbb{T}^2)}^2 &\leq \inf_{\varepsilon \in (0,1]} \{C(\varepsilon) \|\nabla u\|_{L^2}^{2(1-\varepsilon)} \|\Delta u\|_{L^2}^{\varepsilon}\} \\ &= \|\nabla u\|_{L^2}^2 \inf_{\varepsilon \in (0,1]} \{C(\varepsilon) \delta^{\varepsilon}\} \\ &= \frac{1}{4\pi} \|\nabla u\|_{L^2}^2 \min_{\varepsilon \in (0,1]} \{e^{\varepsilon \log \delta} (\varepsilon^{-1} + O_{\varepsilon \rightarrow 0}(1))\} \\ &= \frac{1}{4\pi} \|\nabla u\|_{L^2}^2 (e \log \delta + O_{\delta \rightarrow \infty}(1)) \end{aligned} \quad (4.8)$$

(the last minimum being achieved for  $\varepsilon \sim (\log \delta)^{-1}$  if  $\delta$  is large). Thus, the above described approach *is not sharp* and gives an  $e$ -times larger constant for the leading term on the right-hand side of the inequality considered.

This result is not, in fact, surprising if we compare the extremals  $u_{\mu}(x)$  for the critical Sobolev inequality with extremals (4.7) for the interpolation inequality used in the above arguments. Indeed, the first are delta-like spikes situated near zero, but

the others are well-distributed rapidly oscillating functions. Thus, we are applying the interpolation inequality to functions which are very far from the extremals and, for this reason, we may expect that on the extremals, this inequality holds with constant better than unity (see [10]).

By contrast, extremals (4.4) look very similar to  $u_\mu(x)$ : both of them are delta-like spikes with height proportional to  $\log(1/\mu)$  (if we take the optimal  $\varepsilon \sim \log(1/\mu)$ ). Therefore, one may expect that the sharpness of the above scheme is lost mainly due to usage of the interpolation and that it is probably possible to retrieve the sharp constant by using only the first inequality (4.3),

$$\|u\|_{C(\mathbb{T}^2)}^2 \leq \inf_{\varepsilon \in (0,1]} \{C(\varepsilon)\|(-\Delta)^{(1+\varepsilon)/2}u\|_{L^2}^2\}, \tag{4.9}$$

and then computing the infimum in the right-hand side in some ‘more clever’ way.

However, surprisingly, this expectation is *wrong* and approximately the same ‘degree of sharpness’ is lost under the usage of the first, (4.3), and the second, (4.6), inequalities. In order to see this, we compute the leading terms of the asymptotic expansions in  $\mu$  for the left- and right-hand sides of (4.9) on the conditional extremals  $u_\mu(x)$  of the critical Sobolev inequality considered.

LEMMA 4.3. *Let*

$$A(\mu) := \|u_\mu\|_{C(\mathbb{T}^2)}^2, \quad B(\mu) := \inf_{\varepsilon \in (0,1]} \{C(\varepsilon)\|(-\Delta)^{(1+\varepsilon)/2}u_\mu\|_{L^2}^2\}, \tag{4.10}$$

where the functions  $u_\mu(x)$  are given by (1.11). Then, the expansions

$$A(\mu) = \pi^2 \log^2 \frac{1}{\mu} + O\left(\log \frac{1}{\mu}\right), \quad B(\mu) = \pi^2 \alpha \log^2 \frac{1}{\mu} + O\left(\log \frac{1}{\mu}\right) \tag{4.11}$$

hold as  $\mu \rightarrow 0+$ . The constant  $\alpha > 1$  is given by

$$\alpha := \frac{e^{W(-2 \exp(-2))+2} - 1}{(W(-2 \exp(-2)) + 2)^2} \sim 1.544, \tag{4.12}$$

where  $W(z)$  is the principal branch of Lambert’s  $W$ -function; see [11].

*Proof.* The asymptotic expansion for the function  $A(\mu)$  follows from (3.7) and we need only study the function  $B(\mu)$ . To this end, we introduce a function

$$\begin{aligned} h(\mu, \varepsilon) &:= \frac{1}{4\pi^2} \|(-\Delta_x)^{(1+\varepsilon)/2}u_\mu\|_{L^2}^2 \\ &= \sum' \frac{1}{|k|^{2(1-\varepsilon)}(1 + \mu k^2)}. \end{aligned} \tag{4.13}$$

Note that the infimum on the right-hand side of (4.10) is achieved for *small*  $\varepsilon$  when  $\mu$  is small. We may assume, without loss of generality, that  $\varepsilon < 1/2$ . Then, applying estimate (A 1) (see the appendix) we see that the one-dimensional integrals are uniformly bounded as  $\varepsilon \rightarrow 0$  and  $\mu \rightarrow 0$  and we may write that

$$\begin{aligned} f(\mu, \varepsilon) &= \int_{|x|>1} \frac{dx}{|x|^{2(1-\varepsilon)}(1 + \mu|x|^2)} + O_{\mu,\varepsilon}(1) \\ &= 2\pi\mu^{-\varepsilon} \int_{r \geq \mu^{1/2}} \frac{dr}{r^{2(1-\varepsilon)}(1 + r^2)} + O_{\mu,\varepsilon}(1) \end{aligned}$$

$$\begin{aligned} &= 2\pi\mu^\varepsilon \left( \int_0^\infty \frac{dr}{r^{2(1-\varepsilon)}(1+r^2)} - \int_{r \leq \mu^{1/2}} \frac{dr}{r^{2(1-\varepsilon)}(1+r^2)} \right) + O_{\mu,\varepsilon}(1) \\ &= 2\pi\mu^{-\varepsilon} \left( \frac{\pi}{2\sin(\pi\varepsilon)} - \frac{\mu^\varepsilon}{\varepsilon} \right) + O_{\mu,\delta}(1) \\ &= \pi \frac{\mu^{-\varepsilon}(\pi\varepsilon/\sin(\pi\varepsilon)) - 1}{\varepsilon} + O_{\mu,\varepsilon}(1), \end{aligned}$$

where we have used the fact that the first integral in the middle line can be found explicitly and the second one can be computed up to the bounded terms using the expansions

$$\frac{1}{1+x^2} = 1 + \sum_{n=1}^\infty (-1)^n x^{2n}.$$

Now, recalling that  $C(\varepsilon) = 1/4\pi\varepsilon + O_\varepsilon(1)$ , we end up with

$$B(\mu) = \pi^2 \max_{\varepsilon \in (0,1]} \left\{ \left( \frac{1}{\varepsilon} + O_\varepsilon(1) \right) \left( \frac{\mu^{-\varepsilon}(\pi\varepsilon/\sin(\pi\varepsilon)) - 1}{\varepsilon} + O_{\mu,\varepsilon}(1) \right) \right\}.$$

It is not difficult to see that the leading term as  $\mu \rightarrow 0$  in the minimizing problem is given by

$$\begin{aligned} \pi^2 \min_{\varepsilon \in [0,1]} \left\{ \frac{\mu^{-\varepsilon} - 1}{\varepsilon^2} \right\} &= \pi^2 \min_{\varepsilon \in [0,1]} \left\{ \frac{\exp(\varepsilon \log(\mu^{-1})) - 1}{\varepsilon^2} \right\} \\ &= \pi^2 \log^2 \frac{1}{\mu} \min_{\gamma > 0} \left\{ \frac{e^\gamma - 1}{\gamma^2} \right\} \end{aligned} \tag{4.14}$$

and the remainder term will be of the order  $\log(1/\mu)$  as  $\mu \rightarrow 0$ . It only remains to note that the minimum on the right-hand side of (4.14) can be found explicitly in terms of the Lambert W function and coincides with (4.12). Lemma 4.3 is proved.  $\square$

REMARK 4.4. Thus, since the right-hand side of (3.19) computed on the extremals  $u_\mu(x)$  gives the same leading term in the asymptotic expansions as the function  $A(\mu)$ , we see that it is *impossible* to obtain (3.19) with a constant better than  $\alpha/4\pi$  if inequality (4.9) is used (no matter how sharply we further estimate the right-hand side of (4.9)).

We now return to the second of the methods described above. To this end, we estimate the first and the second term on the right-hand side of (4.2) as follows:

$$\begin{aligned} \sum'_{|k| \leq N} |u_k| &= \sum'_{|k| \leq N} |k|^{-1} |k| |u_k| \\ &\leq \left( \sum'_{|k| \leq N} |k|^{-2} \right)^{1/2} \left( \sum'_{|k| \leq N} k^2 |u_k|^2 \right)^{1/2} \\ &\leq \frac{1}{2\pi} \|\nabla u\|_{L^2} \left( \sum'_{|k| \leq N} |k|^{-2} \right)^{1/2} \end{aligned}$$

and

$$\begin{aligned} \sum'_{|k|>N} |u_k| &= \sum'_{|k|>N} |k|^{-2} k^2 |u_k| \\ &\leq \left( \sum'_{|k|>N} |k|^{-4} \right)^{1/2} \left( \sum'_{|k|>N} k^2 |u_k|^2 \right)^{1/2} \\ &\leq \frac{1}{2\pi} \|\Delta u\|_{L^2} \left( \sum'_{|k|>N} |k|^{-4} \right)^{1/2}, \end{aligned}$$

which together with (4.2) lead to the estimate

$$\|u\|_{C(\mathbb{T}^2)}^2 \leq \frac{1}{4\pi^2} \|\nabla u\|^2 \min_{N>0} \left( \left( \sum'_{|k|\leq N} \frac{1}{|k|^2} \right)^{1/2} + \delta^{1/2} \left( \sum'_{|k|>N} \frac{1}{|k|^4} \right)^{1/2} \right)^2, \tag{4.15}$$

with  $\delta = \|\Delta u\|_{L^2}^2 / \|\nabla u\|_{L^2}^2$ . The following lemma gives the asymptotic behaviour of the right-hand side of this inequality as  $\delta \rightarrow \infty$ .

LEMMA 4.5. *Let  $P(\delta)$  be the value of the minimum on the right-hand side of (4.15). Then, this function possesses the expansion*

$$P(\delta) = \frac{1}{4\pi} \left( \log \delta + \log \log \delta + \frac{\beta + \pi}{\pi} \right) + \frac{1 + \log 2}{4\pi} + o(1) \tag{4.16}$$

as  $\delta \rightarrow \infty$ .

*Proof.* As shown in the appendix (see lemma A.4),

$$\sum'_{|k|\leq N} \frac{1}{|k|^2} = 2\pi \log N + \beta + O(N^{-1})$$

as  $N \rightarrow \infty$ . On the other hand, as is not difficult to show, using, say, lemma A.1,

$$\sum'_{|k|>N} \frac{1}{|k|^4} = \int_{|x|>N} \frac{dx}{|x|^4} + O(N^{-3}) = \pi N^{-2} + O(N^{-3}). \tag{4.17}$$

Then, using the obvious fact that the minimum on the right-hand side of (4.15) should be achieved for  $N$  ‘close’ to  $\delta$  ( $C_\gamma^{-1} \delta^{1-\gamma} \leq N_{\min} \leq C_\gamma \delta^{1+\gamma}$  for all  $\gamma > 0$ ), we see that

$$P(\delta) = \frac{1}{2\pi} \min_{N>0} (\log^{1/2}(kN) + \frac{1}{\sqrt{2}} N^{-1} \delta^{1/2})^2 + o(1), \quad k := e^{\beta/2\pi} \tag{4.18}$$

as  $\delta \rightarrow \infty$ . Differentiating the expression on the right-hand side, we see that the minimum is achieved at

$$N(\delta) := \frac{1}{k} \exp \left( -\frac{1}{2} W_{-1} \left( \frac{-1}{k^2 d} \right) \right),$$

where  $W_{-1}(z)$  is, again, the  $-1$ -branch of the Lambert  $W$ -function. Using expansion (3.18) for the Lambert  $W$ -function, we arrive at

$$N_{\min}(\delta) = \delta^{1/2} \sqrt{\log(k^2 d)} \left( 1 + O \left( \frac{\log \log \delta}{\log \delta} \right) \right).$$

Inserting this expression into the right-hand side of (4.18) we end up with (4.16) (after some straightforward computations) and complete the proof of the lemma.  $\square$

REMARK 4.6. Thus, in contrast to the first method, the second gives *two correct terms* in the asymptotic expansion of the function  $\Theta(\delta)$  and the error appears only in the third term (wrong additional constant  $(1 + \log 2)/4\pi$ ; compare (1.13) and (4.16)) and we conclude that the second method is sharper and clearly preferable for the elementary proof of inequalities of this type, at least in the case of tori.

### 5. The algebraic case

In this section, we apply the method developed above to the simpler case of *algebraic* interpolation inequalities of the form (1.2) on the torus. We are able to treat the case of tori of arbitrary dimension  $d$ ; however, in order to avoid the computation of the analogues of the integration constant  $\beta$  (which is difficult and requires more refined analysis), we restrict ourselves to the case where one of the interpolation spaces is  $L^2$ . So, we want to analyse the interpolation inequality

$$\|u\|_{C(\mathbb{T}^d)}^2 \leq c_d(n) \|u\|_{L^2}^{2-d/n} \|(-\Delta_x)^{n/2} u\|_{L^2}^{d/n}, \quad n > \frac{1}{2}d, \tag{5.1}$$

for  $(2\pi)^d$ -periodic functions with zero mean. Following the above described scheme, we replace inequality (5.1) by the refined one

$$\|u\|_{C(\mathbb{T}^d)}^2 \leq \|u\|_{L^2}^2 \Theta_{d,n}(\delta), \quad \delta := \frac{\|(-\Delta_x)^{n/2} u\|_{L^2}^2}{\|u\|_{L^2}^2} \geq 1, \tag{5.2}$$

where

$$\Theta_{d,n}(\delta) := \sup \left\{ \|u\|_{L^\infty}^2, u \in H^n(\mathbb{T}^d), \right. \\ \left. \|u\|_{L^2} = 1, \|(-\Delta_x)^{n/2} u\|_{L^2}^2 = \delta, \int_{\mathbb{T}^d} u(x) dx = 0 \right\}. \tag{5.3}$$

First of all we note that, arguing as in lemma 2.1, we may prove that the maximizer  $u_\delta(x)$  for (5.3) exists. So, we may apply the Lagrange multipliers technique, analogously to theorem 2.3, and obtain the following result.

LEMMA 5.1. *The conditional extremals for (5.2) are given by*

$$u_\mu(x) = \sum' \frac{e^{ik \cdot x}}{1 + \mu|k|^{2n}}, \quad \mu \in (-\infty, -1] \cup (0, +\infty], \tag{5.4}$$

(where  $\sum'$  now means the sum over the lattice  $k \in \mathbb{Z}^d$ , excepting  $k = 0$ ) and, therefore, the desired function  $\Theta_{d,n}(\delta)$  possesses the parametric description

$$\left. \begin{aligned} \Theta_{d,n}(\mu) &:= \frac{1}{(2\pi)^d} \frac{(\sum' 1/(1 + \mu|k|^{2n}))^2}{\sum' 1/(1 + \mu|k|^{2n})^2}, \\ \delta(\mu) &= \frac{\sum' |k|^{2n}/(1 + \mu|k|^{2n})}{\sum' 1/(1 + \mu|k|^{2n})^2}, \end{aligned} \right\} \tag{5.5}$$

where  $\mu \in (-\infty, -1] \cup (0, +\infty]$ . In addition, for every  $\delta \geq 1$  there exists a unique  $\mu = \mu(\delta)$  belonging to that interval (see remark 2.4 concerning the limit values  $\mu = -1$  and  $\mu = \infty$ ).

The proof of this lemma is analogous to theorem 2.3 and, therefore, is omitted.

Furthermore, analogously to (3.7), (3.8) and (3.3), we may find the asymptotic expansions up to exponential terms for all sums involving the parametric definition of the function  $\Theta_n$ .

LEMMA 5.2. *Let  $n \in \mathbb{N}$  and  $2n - d > 0$ . Then, the expansions*

$$\left. \begin{aligned} f(\mu) &:= \sum' \frac{1}{1 + \mu|k|^{2n}} \\ &= \frac{\pi\omega(d)}{2n \sin(\pi d/2n)} \mu^{-d/2n} - 1 + O\left(\exp\left(\frac{-C_n}{\mu^{d/2n}}\right)\right), \\ g(\mu) &:= \sum' \frac{1}{(1 + \mu|k|^{2n})^2} \\ &= \frac{1}{4} \frac{\pi(2n - d)\omega(d)}{n^2 \sin(\pi d/2n)} \mu^{-d/2n} - 1 + O\left(\exp\left(\frac{-C_n}{\mu^{d/2n}}\right)\right), \\ h(\mu) &:= \sum' \frac{|k|^{2n}}{(1 + \mu|k|^{2n})^2} \\ &= \frac{1}{4} \frac{\pi d\omega(d)}{n^2 \sin(\pi d/2n)} \mu^{-1-(d/2n)} + O\left(\exp\left(\frac{-C_n}{\mu^{d/2n}}\right)\right) \end{aligned} \right\} \quad (5.6)$$

hold as  $\mu \rightarrow 0$ . Here,  $\omega(d) := 2\pi^{d/2}/\Gamma(d/2)$  is the volume of the  $(d-1)$ -dimensional unit sphere and  $C_n$  is a positive constant depending on  $n$ .

*Proof.* Expansions (5.6) can be obtained from the Poisson summation formula, analogously to lemma 3.1 but more simply since we do not need to analyse the leading exponentially decaying term here, so we need not find the Fourier transforms explicitly and may just use the fact that the full sums (including the term with  $k = 0$ ) are exponentially close to the corresponding integrals. Note also that, in contrast to §3, we do not have singularities at  $k = 0$  in any sums, so the additional integration constant does not appear and the verification of (5.6) is reduced to computing the multi-dimensional integrals associated with the sums. In turn, the integrals can be straightforwardly computed using hyperspherical coordinates (recall that all the integrals are radially symmetric) and the well-known formulae

$$\left. \begin{aligned} \int_0^\infty \frac{x^m}{(1+x^k)^l} dx &= \frac{1}{k} B\left(\frac{m+1}{k}, l - \frac{m+1}{k}\right), \\ B(x, y) &:= \frac{\Gamma(x)\Gamma(y)}{\Gamma(x+y)}, \quad \Gamma(x)\Gamma(1-x) = \frac{\pi}{\sin \pi x}. \end{aligned} \right\} \quad (5.7)$$

For brevity, we omit the computation of these integrals. Thus, the lemma is proved. □

REMARK 5.3. It is not difficult to see that the positive constant  $C_n$  in expansions (5.6) decays as  $n \rightarrow \infty$ :  $C_n \sim C/n$ . Indeed, the analytic function  $z \rightarrow$



$1/(1 + z^{2n})$  has simple poles at

$$z_k := -\sin(\pi k/2n) + i \cos(\pi k/2n)$$

and at least one of them is at distance  $\sim \pi/2n$  from the real axis. This explains why expansions (5.6) start to work only for extremely small  $\mu$  (hence, extremely large  $\delta$ ) if  $n$  is large enough (see examples below).

The next lemma is the analogue of lemma 3.6 for this case.

LEMMA 5.4. *Let  $n \in \mathbb{N}$  and  $2n - d > 0$ . Then, the function  $\Theta_{d,n}(\delta)$  possesses the expansion*

$$\Theta_{d,n}(\delta) = \frac{1}{(2\pi)^d} \left( \frac{\pi\omega(d)}{\sin(\pi d/2n)d^{d/2n}(2n-d)^{1-d/2n}} \delta^{d/2n} - \frac{2n}{2n-d} - \frac{2d^{1+d/2n}n^2 \sin(\pi d/2n)}{\pi\omega(d)(2n-d)^{2+d/2n}} \delta^{-d/2n} \right) + O(\delta^{-d/n}) \quad (5.8)$$

as  $\delta \rightarrow \infty$ .

The proof of this statement is based on expansions (5.6) and consists of straightforward calculations, which are left to the reader.

We are now ready to state the improved version of (5.1) with a remainder term, which can be considered as the main result of this section.

THEOREM 5.5. *Let  $n \in \mathbb{N}$  and  $2n - d > 0$ . Then,*

$$\|u\|_{C(\mathbb{T}^d)}^2 \leq c_d(n) \|u\|_{L^2}^{2-d/n} \|(-\Delta_x)^{n/2} u\|_{L^2}^{d/n} - K_d(n) \|u\|_{L^2}^2 \quad (5.9)$$

holds for all  $(2\pi)^d$ -periodic functions with zero mean, where

$$c_d(n) := \frac{1}{(2\pi)^d} \frac{\pi\omega(d)}{\sin(\pi d/2n)d^{d/2n}(2n-d)^{1-d/2n}}$$

and the constant  $K_d(n) \leq 2n/(2\pi)^d(2n-d)$  can be found from

$$K_d(n) := \sup_{\delta \geq 1} \{c_d(n)\delta^{d/2n} - \Theta_{d,n}(\delta)\}. \quad (5.10)$$

*Proof.* The finiteness of supremum (5.10) is guaranteed by expansions (5.8) coupled with the continuity of the function  $\Theta_{d,n}$ . The validity of (5.9) then follows immediately from the definitions of  $\Theta_{d,n}$  and  $K_d(n)$ . The inequality  $K_d(n) \leq 2n/(2\pi)^d(2n-d)$  follows from the fact that, according to (5.8), the limit of the right-hand side of (5.10) as  $\delta \rightarrow \infty$  is exactly  $2n/(2\pi)^d(2n-d)$ .  $\square$

REMARK 5.6. We emphasize that the first constant  $c_d(n)$  in (5.9) coincides with the analogous constant (1.3) for the case of the whole of  $\mathbb{R}^d$  for all admissible  $d, n \in \mathbb{N}$ . Thus, in the improved form (5.9) of the interpolation inequality, the difference between the two alternative cases discussed in the introduction is now transformed to the question of whether or not the second constant  $K_d(n)$  is non-negative.

If  $K_d(n) > 0$  (as we will see below, this is true for the one-dimensional case,  $d = 1$ , as well as for the multi-dimensional case if  $n$  is not large), the second term

in (5.9) is *negative* and can be treated as a remainder Brézis–Lieb-type term in the usual interpolation inequality (5.1). In particular, this term can simply be omitted, which shows that, in such a case, the best constant in (5.1) in the space periodic case coincides with the analogous constant for  $\mathbb{R}^d$ . In addition, if  $K_d(n)$  is *strictly less* than  $2n/(2\pi)^d(2n-d)$ , we may conclude that there exist exact extremals for (5.9) (this follows from the fact that the third term in (5.8) is strictly negative).

By contrast, if  $K_d(n) < 0$ , the lower-order term in (5.8) becomes *positive* and cannot be removed without increasing the first constant  $c_d(n)$ . Thus, according to theorem 5.5, adding the positive *lower-order* corrector to classical inequality (5.1) allows us to not increase the constant in the leading term (which remains the same as in the case of  $\mathbb{R}^d$ ). This improvement may be essential in practice since, in many applications to PDEs, inequalities (5.1) are used in order to estimate the *higher-order* norm in situations where the lower-order norm is already estimated (say, via the energy inequality; see [30]). In that case, only the constant in the leading term is truly essential and the approach with the corrector term allows us not only to decrease it, but also gives its exact analytical value.

REMARK 5.7. Note that the possibility of keeping the leading constant the same as in  $\mathbb{R}^d$  in the case of bounded domains, just by adding the lower-order corrector, is not an obvious fact and it is specific to the domains without boundary or those with Dirichlet boundary conditions. Indeed, let us consider the case where  $\Omega = [-\pi, \pi]^d$  with, say, Neumann boundary conditions. Then, because of the symmetries, the functions  $u_\mu(x - \{\pi\}^d)$  (our extremals, but shifted to the ‘corner’ of the hypercube  $\Omega$ ) will satisfy the boundary conditions. However, only ‘one quarter’ of the functions are now in the domain  $\Omega$ , so the  $C$ -norms of the functions remain unchanged, but all  $H^s$ -norms are halved. Thus, the leading constant  $c_d(n)$  in (5.9) must be at least four times larger than for  $\mathbb{R}^d$ ; see also [25] for the case of domains with cusps where not only the coefficient, but also the form of the leading term in the asymptotic expansions, will be different.

We conclude this subsection by considering the low-dimensional cases including the numerical analysis of the constant  $K_d(n)$  for small  $n$  and  $d$ .

### 5.1. The one-dimensional case $d = 1$

A comprehensive analysis of (5.1) was given in [20]. In particular, as proved there, the best constant in the one-dimensional case of (5.1) is exactly  $c_1(n)$  for all  $n \geq 1$  and the exact extremals do not exist. We use this information in order to verify that the constant  $K_1(n)$  is strictly positive.

LEMMA 5.8. *Let  $d = 1$  and  $n \geq 1$ . Then, the best constant  $K_1(n)$  in the remainder term is strictly positive.*

*Proof.* The negativity of  $K_1(n)$  would contradict the fact that the best constant in (5.1) is  $c_1(n)$ , as proved in [20], so we need only exclude the case  $K_1(n) = 0$ .

Assume now that  $K_1(n) = 0$ . Then, again, in the light of (5.8), the zero supremum in (5.10) must be a maximum achieved at some point  $\delta = \delta_* < \infty$ . Consequently, the associated conditional extremal  $u_{\mu(\delta_*)}(x)$  is an *exact* extremum function for (5.1), which contradicts the result of [20]. Thus,  $K_1(n) > 0$  and the lemma is proved.  $\square$

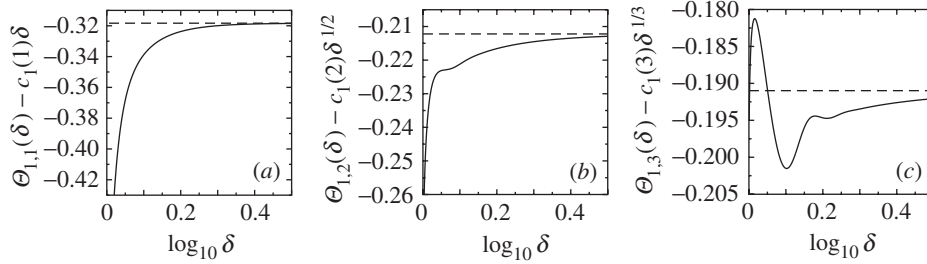

Figure 2. Plots of  $\Theta_{1,n}(\delta) - c_1(n)\delta^{1/n}$  against  $\delta$  in the one-dimensional case for (a)  $n = 1$ , where the dotted line corresponds to  $-\pi$ , (b)  $n = 2$ , where the dotted line corresponds to  $-2/3\pi$ , and (c)  $n = 3$ , where the dotted line corresponds to  $-3/5\pi$ .

REMARK 5.9. Recall that, in the one-dimensional case, each of the functions  $f(\mu)$ ,  $g(\mu)$  and  $h(\mu)$  can be written in closed form through the logarithmic derivatives of the Euler  $\Gamma$ -function using the famous identity

$$\frac{d}{dx} \log \Gamma(x) + \gamma = \sum_{k=0}^{\infty} \left( \frac{1}{k+1} - \frac{1}{k+x} \right)$$

and by expanding the function  $1/(1 + \mu k^{2n})$  as a sum of elementary fractions. Although this formula is not very helpful for asymptotic analysis, it may be used for high precision numerics since effective ways to compute the logarithmic derivatives for the gamma functions are known and incorporated in the algebraic manipulation software (e.g. Maple).

We now present some numerical results for  $n$  not large.

Let  $n = 1$  or  $n = 2$ . Then, as can be seen in figure 2, the function

$$F(\delta) := \Theta_n(\delta) - c_1(n)\delta^{1/(2n)} + \frac{n}{\pi(2n-1)} \tag{5.11}$$

is monotone increasing and is *negative* for all  $\delta \geq 0$  (for large  $\delta$  this property is obvious since the third term in (5.8) is negative and tends to zero, and for  $\delta$  not large the numerics are reliable). Thus, we see that  $K_1(1) = 1/\pi$ ,  $K_1(2) = 2/3\pi$  and, therefore, the inequalities

$$\begin{aligned} \|u\|_{C(\mathbb{T}^1)}^2 &\leq \|u\|_{L^2} \|u'\|_{L^2} - \frac{1}{\pi} \|u\|_{L^2}^2, \\ \|u\|_{C(\mathbb{T}^1)}^2 &\leq \frac{\sqrt{2}}{\sqrt[4]{27}} \|u\|_{L^2}^{3/2} \|u''\|_{L^2}^{1/2} - \frac{2}{3\pi} \|u\|_{L^2}^2 \end{aligned}$$

hold and exact extremals for this inequality do not exist. Note also that, in contrast to the case  $n = 1$ , the graph of  $F(\delta)$  becomes *non-concave* and we may expect that a local maximum for small  $\delta$  will appear for larger  $n$ . Indeed, for  $n = 3$ , in figure 2, we see two local maxima for the function, one of which becomes *larger* than zero.

Therefore,  $K_1(3) < 3/5\pi \sim 0.19099$  and, in contrast to (5.1), exact extremals for the improved version (5.9) exist. In addition, according to our computations,  $K_1(3) \sim 0.181232$  and is achieved at  $\delta = 1.43404$ .

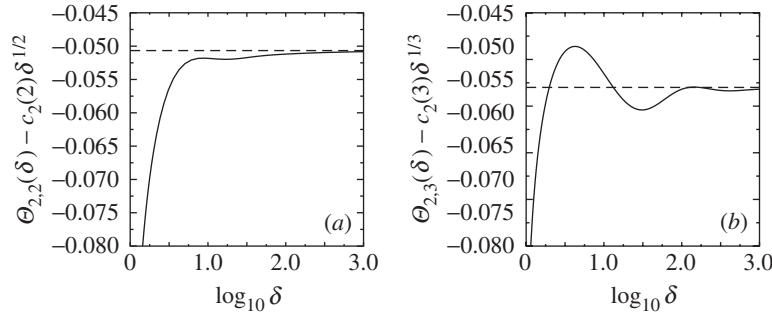

Figure 3. Plots of  $\Theta_{2,n}(\delta) - c_2(n)\delta^{1/n}$  against  $\delta$  in the two-dimensional case for (a)  $n = 2$ , where the dotted line corresponds to  $-(2\pi^2)^{-1}$ , and (b)  $n = 3$ , where the dotted line corresponds to  $-3/8\pi^2$ .

We have observed the analogous phenomenon for all larger  $n$ , so the conjecture that  $K_1(n) < n/\pi(2n - 1)$  for all  $n \geq 3$ , and probably tends to zero as  $n \rightarrow \infty$ , looks reasonable.

REMARK 5.10. Thus, even in the simplest one-dimensional case, our method allows not only the reproduction of known results, but also gives some interesting new information about remainders of the Brézis–Lieb type.

### 5.2. The two-dimensional case $d = 2$

In contrast to the one-dimensional case, the situation here is essentially less understood and, to the best of our knowledge, the exact value of  $c_2(n)$  was not known even for  $n = 2$  (note that the inequality  $c_2(2) < 1/\pi$  was established in [22] although, as we will see,  $c_2(2) = \frac{1}{4}$ ). We also mention that the analogous problem on the two-dimensional sphere  $\mathbb{S}^2$  has been studied by Ilyin [21] and it was found that for  $n \geq 8$  the corresponding constant becomes *strictly* larger than the analogous constant for  $\mathbb{R}^2$  and can be found only numerically. As we will see, the same phenomenon also occurs on the torus for  $n > 9$ .

We now present our numerical study of the constant  $K_2(n)$ . Let  $n = 2$  (the least possible value in the two-dimensional case). As figures 3 and 4 show, the function  $F(\delta) := \Theta_n(\delta) - c_2(n)\delta^{1/n} + n/4\pi^2(n - 1)$  remains negative (although not monotone increasing; again, the negativity of the third term in (5.8) guarantees negativity for large  $\delta$  and we need only check it for  $\delta$  not large, where the numerics are reliable). Thus,  $K_2(2) = n/4\pi^2(n - 1)$  and

$$\|u\|_{C(\mathbb{T}^2)}^2 \leq \frac{1}{4} \|u\|_{L^2} \|\Delta_x u\|_{L^2} - \frac{1}{2\pi^2} \|u\|_{L^2}^2 \tag{5.12}$$

holds for all  $2\pi \times 2\pi$ -periodic functions with zero mean (and there are no exact extremals for the inequality).

Now, let  $n = 3$ . Then, as we see from figure 3, the function  $F$  is *positive* for  $1.98 \leq \delta \leq 13.2$ , therefore  $K_2(3) < 3/8\pi^2$ , but still remains positive. Thus, analogously to the one-dimensional case, exact extremals appear for (5.12) at  $n = 3$  and we may compute the sharp value of  $K_2(3)$  only numerically.

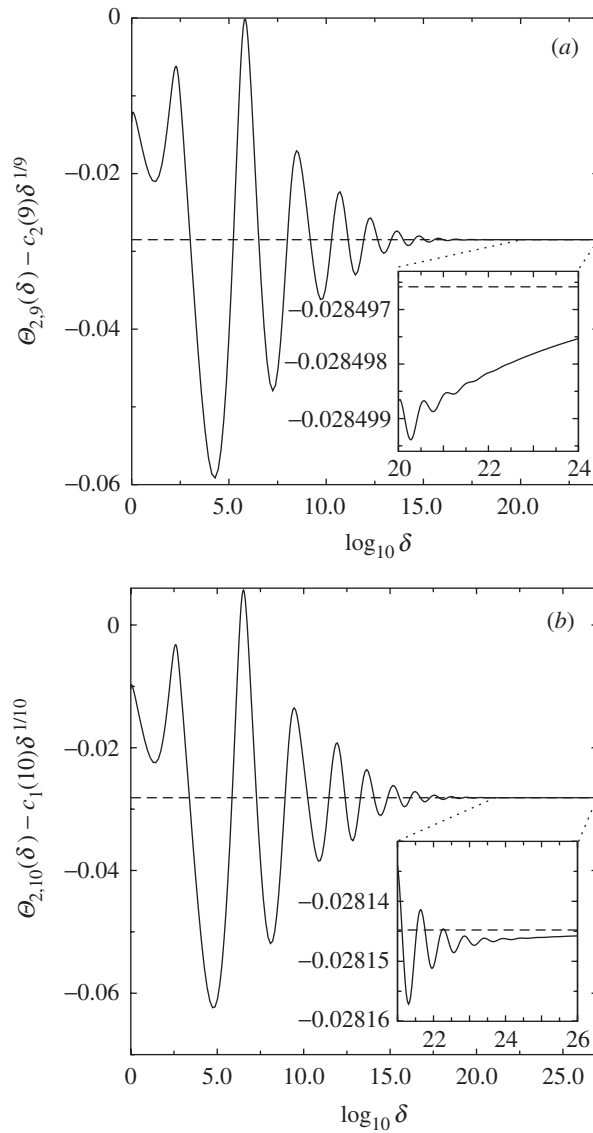

Figure 4. Plots of  $\Theta_{2,n}(\delta) - c_2(n)\delta^{1/n}$  against  $\delta$  in the two-dimensional case, for (a)  $n = 9$ , where the dotted line corresponds to  $-9/32\pi^2$ , and (b)  $n = 10$ , where the dotted line corresponds to  $-5/18\pi^2$ .

As our computations show, the positive maximum of  $F$  will only grow when  $n$  grows, so we expect that this phenomenon holds for all  $n \geq 3$ . In addition, we see that the coefficient  $K_2(n)$  remains positive until  $n \leq 9$ , but for  $n = 10$  the value  $K_2(10)$  becomes *strictly negative*. This means that (5.9) no longer holds for  $K_2 = 0$  and we need a *positive* lower-order corrector in order to be able to use the sharp constant  $c_2(n)$  in the leading term.

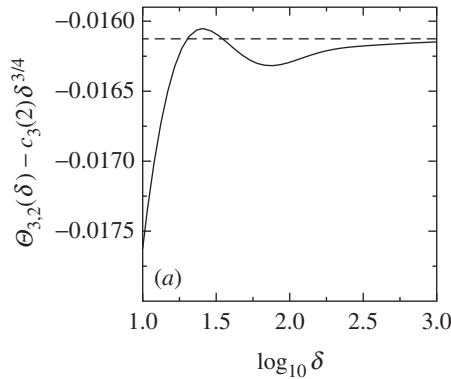

Figure 5. Plot of  $\Theta_{3,n}(\delta) - c_3(n)\delta^{3/2n}$  against  $\delta$  in the three-dimensional case for (a)  $n = 2$ , where the dotted line corresponds to  $-(2\pi^3)^{-1}$ .

REMARK 5.11. Thus, using our approach, one can not only verify the new inequality (5.12), where all the constants are the best possible, but also prove that the constant  $c_2(n)$  can be chosen in an optimal way (coinciding with the analogous constant for  $\mathbb{R}^2$ ) for all  $n \geq 2$ , if a (possibly positive) lower-order corrector is added. The lower-order corrector indeed becomes positive for large  $n$  ( $n \geq 10$ ) but remains negative otherwise.

**5.3. The three-dimensional case  $d = 3$**

In the case  $n = 2$ , the numerics show that  $K_3(2) < 1/2\pi^3$ , but remains *positive*; see figure 5(a), in which we have plotted  $F(\delta) := \Theta(\delta) - (\sqrt{2}\sqrt[4]{3}/6\pi)\delta^{3/4}$ . We find that  $K_3 \sim 0.996/2\pi^3 \sim 0.01605$ , achieved at  $\delta = 25.6$ , which gives the exact extremals for (5.9).

Analogously to the two-dimensional case, the function  $F$  becomes more oscillatory when  $n$  grows and, for  $n \geq 6$ , it crosses the  $x$ -axis and the second constant  $K_3(6) < 0$  becomes strictly negative; see figure 5(c). Actually,  $K_3(6)$  is very close to zero ( $K_3(6) \sim -10^{-5}$ ) but is already strictly negative.

**6. The large  $n$  limit**

As we have seen in the previous section, asymptotic expansions (5.8) and (5.6), which do not contain any oscillatory terms, start to work only for extremely large  $\delta$  (extremely small  $\mu$ ) if  $n$  is large enough. In contrast to this, as the numerics show, the difference between  $\Theta_{k,n}(\delta)$  and the leading term of its expansions

$$F_{d,n}(\delta) := \Theta_{d,n}(\delta) - c_d(n)\delta^{1/2n} \tag{6.1}$$

is highly oscillatory when  $\delta$  is not extremely large (and the values of the second constant  $K_d(n)$  in (5.9) are determined exactly by this transient part if  $n$  is large). The aim of this section is to clarify the nature of this oscillation by studying the large  $n$  limit ( $n \rightarrow \infty$ ) of the properly scaled function (6.1). As we know, there is an essential difference between the one-dimensional and multi-dimensional cases (since, in particular,  $K_1(n)$  is always positive in one-dimensional and may be negative in the multi-dimensional case), so we will consider these two cases separately.

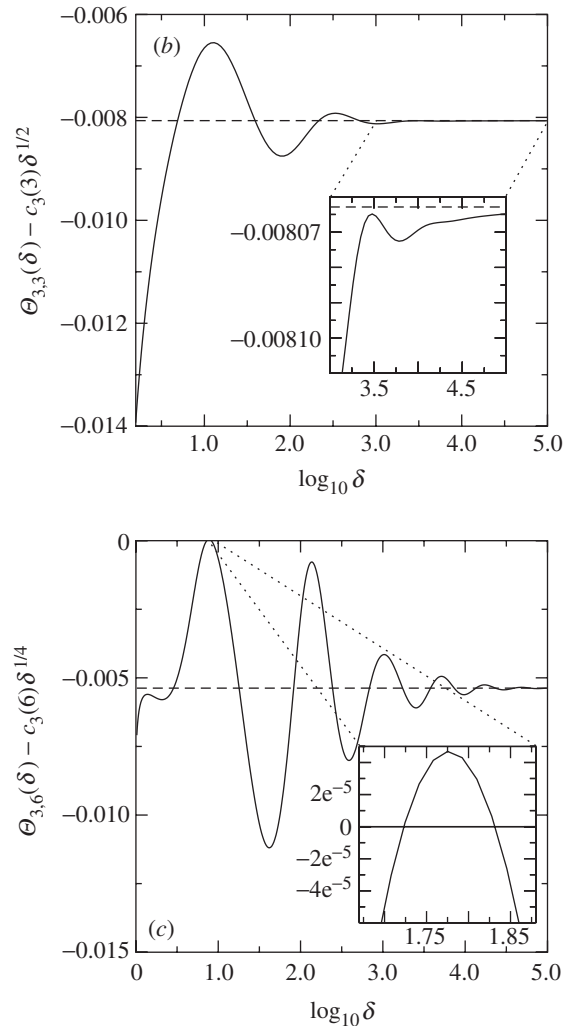

Figure 5. Plots of  $\Theta_{3,n}(\delta) - c_3(n)\delta^{3/2n}$  against  $\delta$  in the three-dimensional case for (b)  $n = 3$ , where the dotted line corresponds to  $-(4\pi^3)^{-1}$ , and (c)  $n = 6$ , where the dotted line corresponds to  $-(6\pi^3)^{-1}$ .

**6.1. The one-dimensional case: regular oscillations**

We introduce a scaled parameter  $z$  such that  $\mu := z^{-2n}$  and write function  $F_{d,n}$  as

$$F_{1,n}(z) := \frac{1}{2\pi} \frac{f(z^{-2n})^2}{g(z^{-2n})} - c_1(n) \left( \frac{h(z^{-2n})}{g(z^{-2n})} \right)^{1/2n} \tag{6.2}$$

and pass to the pointwise limit  $n \rightarrow \infty$  in every term of this formula. Clearly,

$$c_1(n) = \frac{1}{\pi} \left( 1 + \frac{\log(2n-1)}{2n} + O(1/n) \right) \quad \text{and} \quad \lim_{n \rightarrow \infty} c_1(n) = \frac{1}{\pi}. \tag{6.3}$$

The following lemma gives the pointwise limit of the other terms in (6.2).

LEMMA 6.1. *The pointwise limit*

$$\delta_\infty(z) := \lim_{n \rightarrow \infty} \left( \frac{h(z^{-2n})}{g(z^{-2n})} \right)^{1/2n}, \quad z \geq 1, \tag{6.4}$$

as  $n \rightarrow \infty$  is a continuous piecewise smooth function given by

$$\delta_\infty(z) = \begin{cases} l, & z \in [l, \sqrt{l(l+1)}], \quad l \in \mathbb{N}, \\ z^2/(l+1), & z \in [\sqrt{l(l+1)}, l+1], \quad l \in \mathbb{N}, \end{cases} \tag{6.5}$$

and the limit  $n \rightarrow \infty$  of the first term on the right-hand side of (6.2) is a piecewise constant function given by

$$\theta_\infty(z) := \lim_{n \rightarrow \infty} \frac{f(z^{-2n})^2}{g(z^{-2n})} = 2[z] \tag{6.6}$$

for all non-integer  $z$  (here  $[z]$  stands for the integer part of  $z$ ).

*Proof.* We first check (6.5). Clearly,  $\lim_{n \rightarrow \infty} (g(z^{-2n}))^{1/2n} = 1$ , so we need only find the limit of

$$\left( \sum_{k \in \mathbb{Z}} \frac{k^{2n}}{(1 + (k/z)^{2n})^2} \right)^{1/2n}. \tag{6.7}$$

Let  $z \in (l, l+1)$ . Then, for  $k \leq l$ , the  $k$ th term is approximately  $k^{2n}$  and the largest term corresponds to  $k = l$ . For  $k \geq l+1$ , the denominator becomes large. Neglecting the term 1, we see that the  $k$ th term is close to  $(z^2/k)^{2n}$  and the largest term corresponds to  $k = l+1$ . Thus,

$$\lim_{n \rightarrow \infty} \left( \sum_{k \in \mathbb{Z}} \frac{k^{2n}}{(1 + (k/z)^{2n})^2} \right)^{1/2n} = \max\{l, z^2/(l+1)\}, \quad z \in (l, l+1),$$

which gives (6.4).

In order to verify (6.6) for  $z \in (l, l+1)$ , it is enough to note that in both sums (for  $f$  and for  $g$ ) the  $k$ th term tends to one or to zero if  $k \leq l$  or  $k \geq l+1$ , respectively (actually, the limit value is slightly different for integer points, but this is not important for our purposes). Thus, the lemma is proved.  $\square$

COROLLARY 6.2. *Let  $z \in (l, l+1)$ ,  $l \in \mathbb{N}$ . Then,*

$$F_{1,\infty}(z) := \lim_{n \rightarrow \infty} F_{1,n}(z) = \frac{1}{\pi} \begin{cases} 0, & z \in (l, \sqrt{l(l+1)}), \\ l - z^2/(l+1), & z \in [\sqrt{l(l+1)}, l+1), \end{cases} \tag{6.8}$$

and, therefore,

$$\max\{F_{1,\infty}(z)\} = 0, \quad \inf\{F_{1,\infty}(z)\} = -\frac{1}{\pi}$$

and the infimums are achieved as  $z \rightarrow l-$ ,  $l = 2, 3, \dots$

COROLLARY 6.3. *The second constant  $K_1(n)$  in (5.9) satisfies*

$$\lim_{n \rightarrow \infty} K_1(n) = 0. \tag{6.9}$$



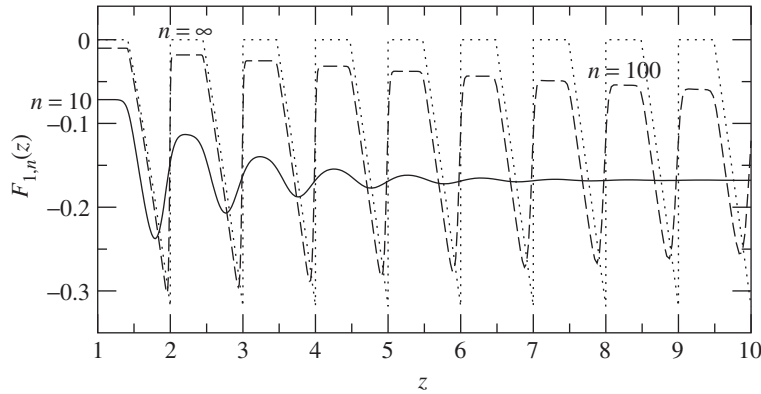

Figure 6. Plots of  $F_{1,n}(z)$  for  $n = 10, 100$  and as  $n \rightarrow \infty$ .

From the previous section, we know that  $K_1(n) \geq 0$  and the limit (6.8) then shows that the limit of  $K_1(n)$  must be equal to zero.

The results of our numerical simulations for  $n = 10, 100$  and the infinite limit are shown in figure 6. We see that, even for the case  $n = 10$ , the limit function  $F_{1,\infty}(z)$  allows prediction of the positions of first maxima and minima of  $F_{1,5}(z)$ . For  $n = 100$ , we already see similar oscillations on the whole interval  $z \in [1, 10]$  (which covers the interval  $\delta \leq 10^{50}$  in the unscaled variables) and for larger  $n$  we also see quantitative agreement with the limit case. Thus, the limit function  $F_{1,\infty}(z)$  encapsulates the nature of *regular* oscillations of  $F_{1,n}(z)$  for large  $n$ .

**6.2. The multi-dimensional case: irregular oscillations**

We now turn to the multi-dimensional case. In order to avoid technicalities, we concentrate only on the two-dimensional case, although the situation is similar for  $d > 2$ . In fact, the pointwise limit of the function  $F_{2,n}(\delta)$  as  $n \rightarrow \infty$  can be found analogously to the one-dimensional case, but the behaviour of the limit function will be much more irregular than in the one-dimensional case, for number-theoretic reasons. We introduce a slightly different scaling of the parameter  $\mu$ , namely, that  $\mu = z^{-n}$ , and consider the function

$$F_{2,n}(z) := \frac{1}{4\pi^2} \frac{f(z^{-n})^2}{g(z^{-n})} - c_2(n) \left( \frac{h(z^{-n})}{g(z^{-n})} \right)^{1/n}. \tag{6.10}$$

As in the one dimensional case, we find the pointwise limit of every term on the right-hand side of (6.10). First of all, clearly,

$$\lim_{n \rightarrow \infty} c_2(n) = \frac{1}{4\pi}$$

and the limits of the other terms are given by the following lemma.

LEMMA 6.4. *Let  $l_1$  and  $l_2$  be two successive natural numbers that can be represented as the sum of two squares of integers and let  $z \in (l_1, l_2)$ . Then,*

$$\delta_\infty(z) := \lim_{n \rightarrow \infty} \left( \frac{h(z^{-n})}{g(z^{-n})} \right)^{1/n} = \begin{cases} l_1, & z \in (l_1, \sqrt{l_1 l_2}], \\ z^2/l_2, & z \in [\sqrt{l_1 l_2}, l_2). \end{cases} \tag{6.11}$$

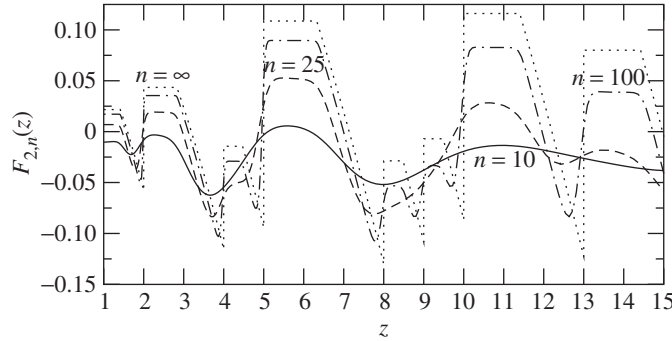

Figure 7. Plots of  $F_{2,n}(z)$  for  $n = 10, 25, 100$  and as  $n \rightarrow \infty$ .

Analogously, the limit  $n \rightarrow \infty$  of the first term on the right-hand side of (6.10) is a piecewise constant function given by

$$\theta_\infty(z) := \lim_{n \rightarrow \infty} \frac{f(z^{-n})^2}{g(z^{-n})} = R_2(l_1), \tag{6.12}$$

where  $R_2(z)$  is the number of integer points  $k \in \mathbb{Z}^2$  such that  $|k|^2 \leq z$ , excluding zero.

The proof of this lemma repeats almost word for word the proof of lemma 6.1 (replacing ‘subsequent integers’ by ‘successive integers which can be represented as a sum of two squares’) and for this reason is omitted.

COROLLARY 6.5. *Let  $l_1$  and  $l_2$  be two subsequent integers that can be represented as a sum of two squares and let  $z \in (l_1, l_2)$ . Then,*

$$F_{2,\infty}(z) := \lim_{n \rightarrow \infty} F_{2,n}(z) = \frac{1}{4\pi^2} \begin{cases} R_2(l_1) - \pi l_1, & z \in (l_1, \sqrt{l_1 l_2}], \\ R_2(l_1) - \pi z^2 / l_2, & z \in [\sqrt{l_1 l_2}, l_2). \end{cases} \tag{6.13}$$

Thus, in contrast to the one-dimensional case, the limit function  $F_{2,\infty}(z)$  contains the function  $R_2(l_1)$  (the number of integer points in a disc of radius  $\sqrt{z}$ ). In addition, the leading term in the expansion of that function is exactly  $\pi z$ . It is known that the remainder  $R_2(l_1) - \pi l_1$  is unbounded both from below and from above, is approximately of order  $l_1^{1/4}$  and demonstrates very irregular oscillatory behaviour for large  $l_1$  (see [17]). This explains, in particular, why  $K_2(n)$  becomes negative for sufficiently large  $n$  as well as suggesting that

$$\lim_{n \rightarrow \infty} K_2(n) = -\infty.$$

We present the results of our numerical simulations for  $n = 10, 25, 100$  and  $n = \infty$  in figure 7.

We see from figure 7 that, even for  $n = 10$  (when the graph first crosses the  $x$ -axis and  $K_2(n)$  becomes strictly negative), the limit function  $F_{2,\infty}(z)$  predicts the positions of maxima and minima of  $F_{2,10}(z)$  and the correspondence with  $F_{2,\infty}(z)$  grows as  $n$  increases. Thus, we see that the irregular oscillations of  $F_{2,n}(z)$  for large  $n$  can be explained by taking the limit  $n \rightarrow \infty$ , and by the irregularity of the

second term in the asymptotic expansion for the number of integer points in a ball of radius  $z$ .

**Appendix A. Exact formula for the integration constant  $\beta$**

The aim of this appendix is to find analytically the value of the integration constant  $\beta$  occurring in asymptotics (3.7) and (3.8). We start by recalling the standard technique of estimating sums by integrals, adapted to the two-dimensional case.

LEMMA A.1. *Let the function  $R: \mathbb{R}_+ \rightarrow \mathbb{R}_+$  be monotone decreasing. Then,*

$$\int_{\Omega} R(|x|) \, dx - 4 \int_1^{\infty} R(x) \, dx - 4R(1) \leq \sum' R(|k|) \leq \int_{\Omega} R(|x|) \, dx + 4 \int_1^{\infty} R(x) \, dx + 4R(1) + 4R(\sqrt{2}), \tag{A 1}$$

where  $\Omega := \{(x, y) \in \mathbb{R}^2, \max\{|x|, |y|\} \geq 1\}$ .

*Proof.* We use the obvious estimate

$$\int_{C_{(k_1-1, k_2-1)}} R(|x|) \, dx \geq R(|k|) \geq \int_{C_{k_1, k_2}} R(|x|) \, dx,$$

where the right-hand estimate holds for all  $k_i \geq 0$  (and  $C_k := [k_1, k_1 + 1] \times [k_2, k_2 + 1]$ ), and, for the validity of the left estimate, we need  $k_i \geq 1$ . Thus,

$$\sum'_{k_i \geq 0} R(|k|) \geq \int_{\Omega_+} R(|k|) \, dx \tag{A 2}$$

(with  $\Omega_+ := \Omega \cap \{x \geq 0, y \geq 0\}$ ) and

$$\sum' R(|k|) \geq \int_{\Omega} R(|k|) \, dx - 4 \sum_{k=1}^{\infty} R(k) \geq \int_{\Omega} R(|x|) \, dx - 4 \int_1^{\infty} R(k) \, dk - 4R(1),$$

where we have used that

$$\sum_{k=2}^{\infty} R(k) \leq \int_1^{\infty} R(x) \, dx.$$

On the other hand,

$$\sum_{k_i \geq 1, k \neq (1,1)} R(|k|) \leq \int_{\Omega_+} R(|x|) \, dx,$$

which together with (A 2) gives the left-hand side of (A 1) and completes the proof of the lemma. □

The next lemma gives the formula for  $\beta$  in terms of a two-dimensional extension of the Euler constant.

LEMMA A.2. *The integration constant  $\beta$  is the following two-dimensional analogue of the Euler–Mascheroni constant:*

$$\beta = \lim_{N \rightarrow \infty} \left( \sum'_{|k| \leq N} \frac{1}{k^2} - 2\pi \log N \right). \tag{A 3}$$

*Proof.* We write out the function  $f$  in the form

$$f(\mu) = \lim_{N \rightarrow \infty} \left( \sum'_{|k| \leq N} \frac{1}{k^2} - \sum'_{|k| \leq N} \frac{\mu}{1 + \mu k^2} \right) := \lim_{N \rightarrow \infty} \left( \sum'_{|k| \leq N} \frac{1}{k^2} - \varphi_N(\mu) \right)$$

and find the asymptotic behaviour for  $\varphi_N(\mu)$  by replacing the sum with the corresponding integral using the analogue of (A 1). Indeed, the one-dimensional integrals are of order  $\mu^{1/2}$  uniformly with respect to  $N$  and the sum of all terms for which  $N - C \leq |k| \leq N + C$  is also of the order  $\mu^{1/2}$  uniformly with respect to  $N$ ; there are at most  $cN$  such terms and the sum does not exceed  $c(\mu N / (1 + \mu N^2)) \sim \mu^{1/2}$ . Thus,

$$f_N(\mu) = \int_{B_N(0)} \frac{\mu}{1 + \mu|x|^2} dx + O(\mu^{1/2}) = \pi \log(1 + \mu N^2) + O(\mu^{1/2}) \tag{A 4}$$

and the remainder is uniformly small with respect to  $N$  as  $\mu \rightarrow 0$ . This gives that

$$\begin{aligned} \lim_{N \rightarrow \infty} (2\pi \log N - f_N(\mu)) &= -\pi \lim_{N \rightarrow \infty} \log \left( \mu + \frac{1}{N^2} \right) + O(\mu^{1/2}) \\ &= \pi \log \frac{1}{\mu} + O(\mu^{1/2}). \end{aligned} \tag{A 5}$$

Since, by definition, the integration constant  $\beta$  satisfies

$$\beta = \lim_{\mu \rightarrow 0} \left( f(\mu) - \pi \log \frac{1}{\mu} \right),$$

equality (A 5) gives that

$$f(\mu) - \pi \log \frac{1}{\mu} = \lim_{N \rightarrow \infty} (2\pi \log N - f_N(\mu)) + O(\mu^{1/2}) = \beta + O(\mu^{1/2})$$

and passing to the limit  $\mu \rightarrow 0$ , we deduce (A 3). Lemma A.2 is proved. □

**REMARK A.3.** Actually, many constants of type (A 3) are explicitly known (e.g. the so-called Madelung constants, etc.; see [13] and references therein). However, we failed to find the formula for constant (A 3) in the literature, so we will prove the analytic expression for it in terms of the usual Euler constant and the Gamma function in the next lemma, based on the Hardy formula for lattice sums.

**LEMMA A.4.** *The constant  $\beta$  can be expressed in terms of the classical Euler–Mascheroni constant  $\gamma$  as*

$$\beta = \pi\gamma + 4\beta'(1), \tag{A 6}$$

with  $\beta'(1) = \frac{1}{4}\pi(\gamma + 2 \log 2 + 3 \log \pi - 4 \log \Gamma(\frac{1}{4})) \sim 0.19290$  (here  $\beta(z)$  and  $\Gamma(z)$  are the Dirichlet beta and gamma functions, respectively).

*Proof.* We use the explicit formula (4.5) for the lattice sums

$$\begin{aligned} \sum' \frac{1}{k^{2(1+\varepsilon)}} &= 4\zeta(1 + \varepsilon)\beta(1 + \varepsilon) = 4 \left( \frac{1}{\varepsilon} + \gamma + O(\varepsilon) \right) \left( \frac{\pi}{4} + \beta'(1)\varepsilon + O(\varepsilon^2) \right) \\ &= \frac{\pi}{\varepsilon} + \pi\gamma + 4\beta'(1) + O(\varepsilon), \end{aligned} \tag{A 7}$$

where  $\zeta(x)$  is the Riemann zeta function. We also introduce the notation

$$\psi_N := \sum'_{|k| \leq N} \frac{1}{k^2}, \quad \psi_N(\varepsilon) := \sum'_{|k| \leq N} \frac{1}{k^{2(1+\varepsilon)}}, \quad \psi(\varepsilon) := \sum' \frac{1}{k^{2(1+\varepsilon)}}$$

and compute the expansions for

$$\psi(\varepsilon) - \psi_N(\varepsilon) = \sum_{|k| \geq N} \frac{1}{k^{2(1+\varepsilon)}}$$

for small  $\varepsilon$  and large  $N$ . As before, it is not difficult to see that replacing the sum by the integral works and gives that

$$\psi(\varepsilon) - \psi_N(\varepsilon) = \int_{|x| > N} \frac{dx}{|x|^{2(1+\varepsilon)}} + O(N^{-1}) = \frac{\pi}{\varepsilon} N^{-2\varepsilon} + O(N^{-1}) \quad (\text{A } 8)$$

uniformly with respect to  $\varepsilon \rightarrow 0$ . Thus,

$$\lim_{\varepsilon \rightarrow 0} \left( \psi(\varepsilon) - \psi_N(\varepsilon) - \frac{\pi}{\varepsilon} \right) = \frac{\pi}{\varepsilon} [N^{-2\varepsilon} - 1] + O(N^{-1}) = -2\pi \log N + O(N^{-1}).$$

Using also the fact that, for every finite  $N$ ,  $\lim_{\varepsilon \rightarrow 0} \psi_N(\varepsilon) = \psi_N$ , we obtain that

$$\psi_N - 2\pi \log N = \lim_{\varepsilon \rightarrow 0} \left( \psi(\varepsilon) - \frac{\pi}{\varepsilon} \right) + O(N^{-1})$$

and, due to (A 7),

$$\beta = \lim_{\varepsilon \rightarrow 0} \left( \psi(\varepsilon) - \frac{\pi}{\varepsilon} \right) = \pi\gamma + 4\beta'(1).$$

Thus, using the known expression for the derivative of the  $\beta$ -function at  $s = 1$ , we derive the desired formula (A 6) and this completes the proof of the lemma.  $\square$

### Acknowledgements

The authors thank A. Ilyin for many stimulating discussions and comments.

### References

- 1 T. Aubin. Problèmes isopérimétriques et espaces de Sobolev. *J. Diff. Geom.* **11** (1976), 573–598.
- 2 M. Bartuccelli and J. Gibbon. Sharp constants in the Sobolev embedding theorem and a derivation of the Brézis–Gallouet interpolation inequality. *J. Math. Phys.* **52** (2011), 093706.
- 3 A. Biryuk. An optimal limiting 2D Sobolev inequality. *Proc. Am. Math. Soc.* **138** (2010), 1461–1470.
- 4 D. Borwein and J. Borwein. A note on alternating series in several dimensions. *Am. Math. Mon.* **93** (1986), 531–539.
- 5 B. Brandolini, F. Chiacchio and C. Trombetti. Hardy type inequalities and Gaussian measure. *Commun. Pure Appl. Analysis* **6** (2007), 411–428.
- 6 H. Brézis and T. Gallouet. Nonlinear Schrödinger evolution equations. *Nonlin. Analysis* **4** (1980), 677–681.
- 7 H. Brézis and E. Lieb. Sobolev inequalities with remainder terms. *J. Funct. Analysis* **62** (1985), 73–86.
- 8 A. Buslaev and V. Tikhomirov. Inequalities for derivatives in the multi-dimensional case. *Math. Notes* **25** (1979), 59–73.

- 9 I. Chueshov and I. Lasiecka. *Attractors and long-time behavior of second order evolution equations with non-linear damping*. Memoirs of the American Mathematical Society, vol. 195 (Providence, RI: American Mathematical Society, 2008).
- 10 A. Cianchi. Quantitative Sobolev and Hardy inequalities, and related symmetrization principles, in *Sobolev spaces in mathematics I* (ed. V. Maz'ya), International Mathematical Series (Springer, 2009).
- 11 R. M. Corless, G. H. Gonnet, D. E. G. Hare, D. J. Jeffrey and D. E. Knuth. On the Lambert W function. *Adv. Computat. Math.* **5** (1996), 329–359.
- 12 H. Federer and W. Fleming. Normal and integral currents. *Annals Math.* **72** (1960), 458–520.
- 13 S. Finch. *Mathematical constants* (Cambridge University Press, 2003).
- 14 M. Glasser and I. Zucker. Lattice sums. In *Theoretical chemistry: advances and perspectives* (ed. H. Eyring and D. Henderson), vol. 5, pp. 67–139 (Academic, 1980).
- 15 M. Grasselli, J. Schimperna and S. Zelik. On the 2D Cahn–Hilliard equation with inertial term. *Commun. PDEs* **34** (2009), 137–170.
- 16 L. Gross. Logarithmic Sobolev inequalities. *Am. J. Math.* **97** (1975), 1061–1083.
- 17 G. Hardy. The representation of numbers as sums of squares. In *Ramanujan: twelve lectures on subjects suggested by his life and work*, 3rd edn, ch. 9 (New York: Chelsea, 1999).
- 18 S. Ibrahim, M. Majdoub and N. Masmoudi. Global solutions for a semilinear 2D Klein–Gordon equation with exponential type nonlinearity. *Commun. Pure Appl. Math.* **59** (2006), 1639–1658.
- 19 S. Ibrahim, M. Majdoub and N. Masmoudi. Double logarithmic inequality with a sharp constant. *Proc. Am. Math. Soc.* **135** (2007), 87–97.
- 20 A. Ilyin. Best constants in multiplicative inequalities for sup-norms. *J. Lond. Math. Soc.* **58** (1998), 84–96.
- 21 A. Ilyin. Best constants in Sobolev inequalities on the sphere and in Euclidean space. *J. Lond. Math. Soc.* **59** (1999), 263–286.
- 22 A. Ilyin and E. Titi. Sharp estimates for the number of degrees of freedom for the damped-driven 2D Navier–Stokes equations. *J. Nonlin. Sci.* **16** (2006), 233–253.
- 23 E. Lieb. Sharp constants in the Hardy–Littlewood–Sobolev and related inequalities. *Annals Math.* **118** (1983), 349–374.
- 24 V. Maz'ya. *Sobolev spaces* (Springer, 1985).
- 25 V. Maz'ya and T. Shaposhnikova. Brézis–Gallouët–Wainger-type inequality for irregular domains. *Complex Var. Ellipt. Eqns* **56** (2011), 991–1002.
- 26 K. Moril, T. Sato and H. Wadade. Brézis–Gallouët–Wainger-type inequality with a double logarithmic term in the Hölder space: its sharp constants and extremal functions. *Nonlin. Analysis* **73** (2010), 1747–1766.
- 27 K. Moril, T. Sato and H. Wadade. Sharp constants of Brézis–Gallouët–Wainger-type inequalities with a double logarithmic term on bounded domains in Besov and Triebel–Lizorkin spaces. *Bound. Val. Probl.* **2010** (2010), 584521.
- 28 G. Rosen. Minimum value for C in the Sobolev inequality  $\|\phi^3\| \leq C\|\nabla\phi\|^3$ . *SIAM J. Appl. Math.* **21** (1971), 30–33.
- 29 G. Talenti. Inequalities in rearrangement invariant function spaces. In: *Nonlinear analysis, function spaces and applications*, vol. 5 (Prague: Prometheus Publishing House, 1994).
- 30 R. Temam. *Infinite-dimensional dynamical systems in mechanics and physics*, 2nd edn. Applied Mathematical Sciences, vol. 68 (Springer, 1997).
- 31 H. Triebel. *Interpolation theory, function spaces, differential operators* (Amsterdam: North-Holland, 1978).
- 32 H. Wadade. Remarks on Gagliardo–Nirenberg-type inequality in the Besov and the Triebel–Lizorkin spaces in the limiting case. *J. Fourier Analysis Applic.* **15** (2009), 857–870.
- 33 G. Watson. *The theory of Bessel functions* (Cambridge University Press, 1922).
- 34 V. I. Yudovich. Non-Stationary flows of an ideal incompressible fluid. *USSR Computat. Math. Math. Phys.* **3** (1963), 1407–1456.
- 35 I. Zucker and M. Robertson. A systematic approach to the evaluation of  $\sum_{m,n \neq 0,0} (am^2 + bmn + cn^2)^{-s}$ . *J. Phys. A* **9** (1976), 1215–1225.