

t=1.4 sec

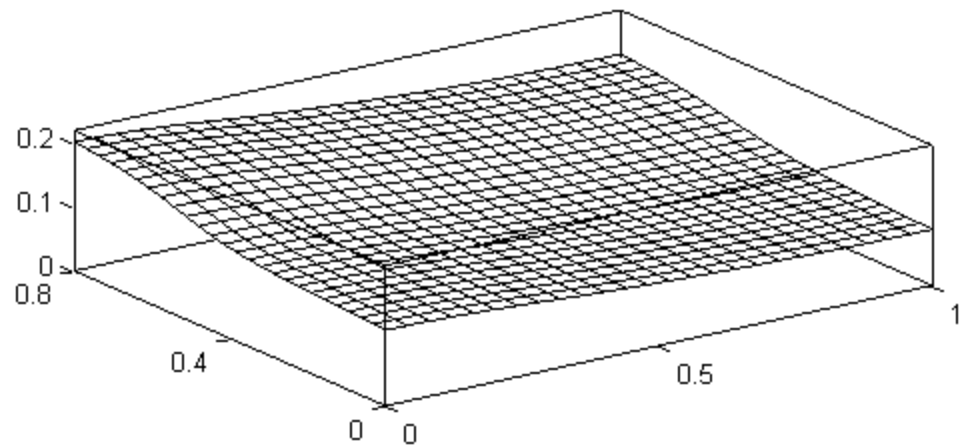

t=1.6 sec

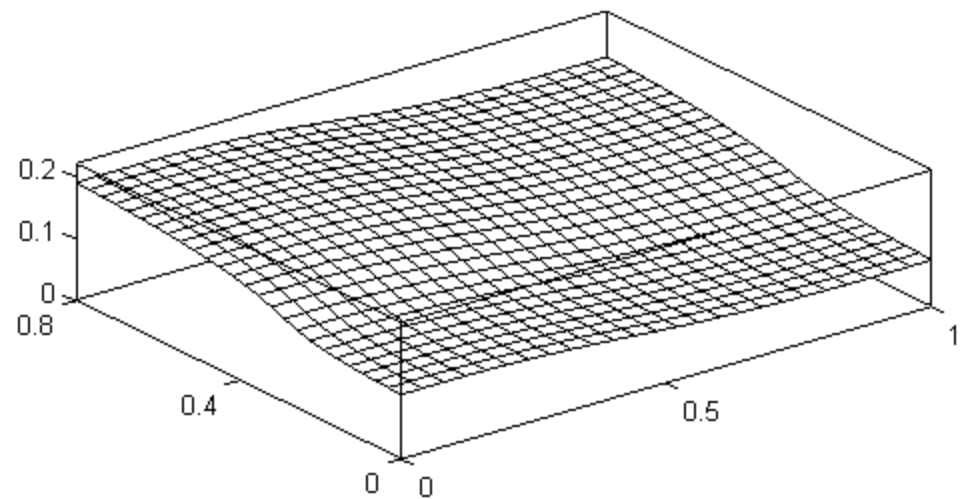

t=2.0 sec

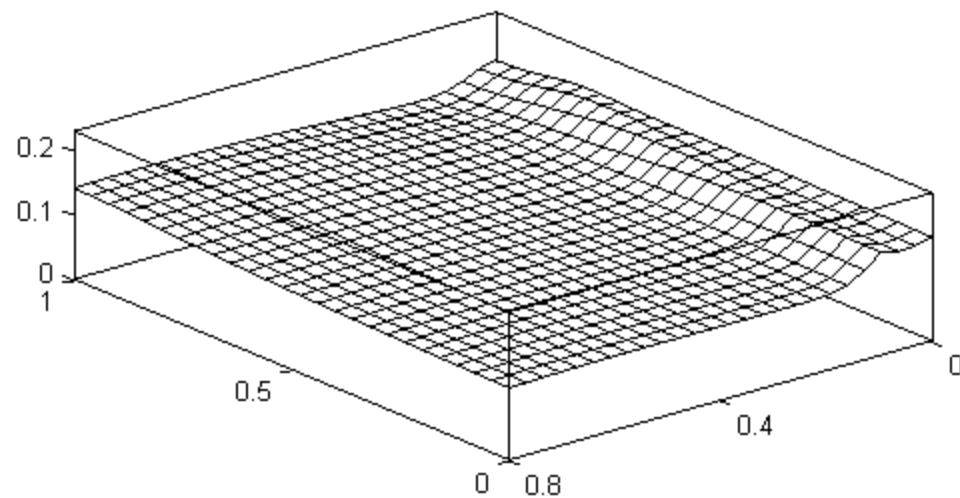

t=2.1 sec

