

t=2.0 sec

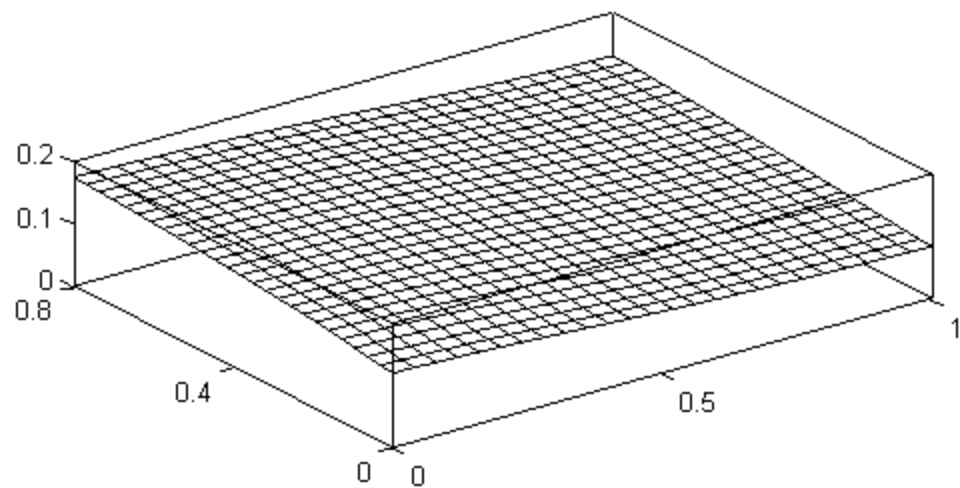

t=2.5 sec

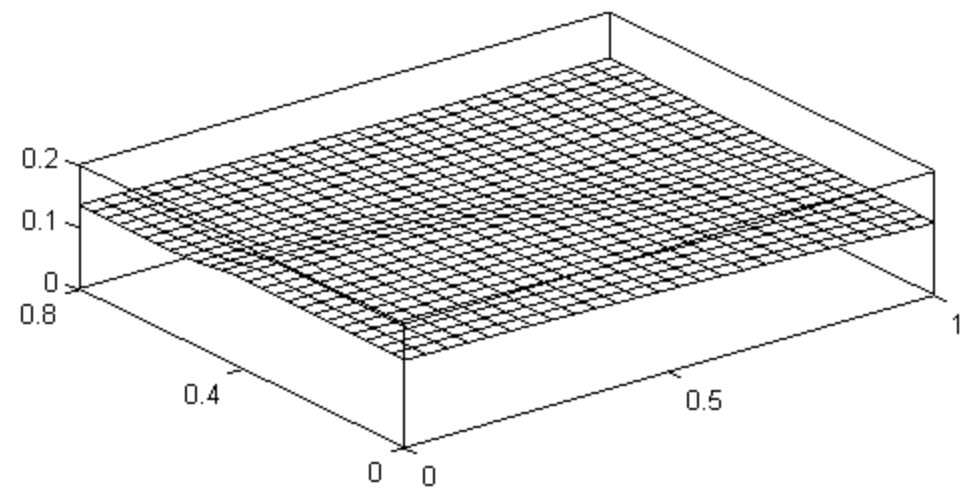

t=3.0 sec

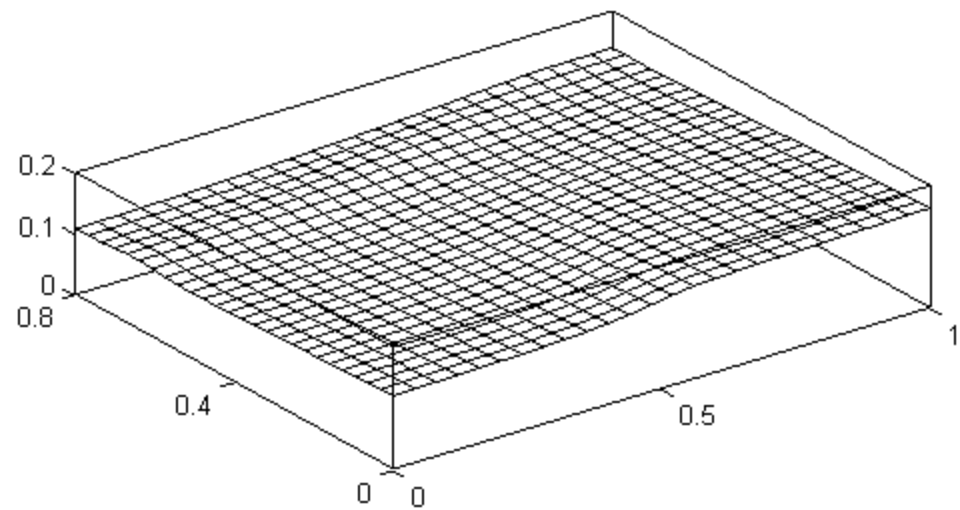

t=3.7 sec

