

t=1.7 sec

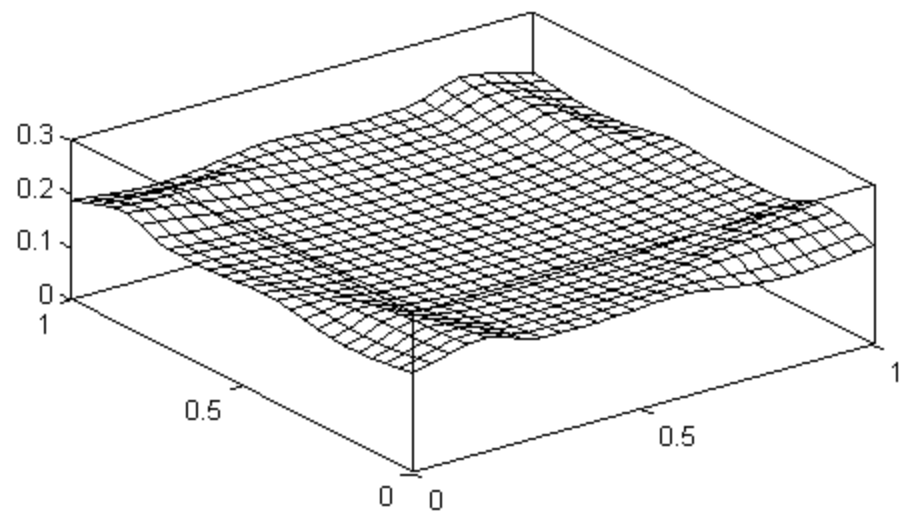

t=1.95 sec

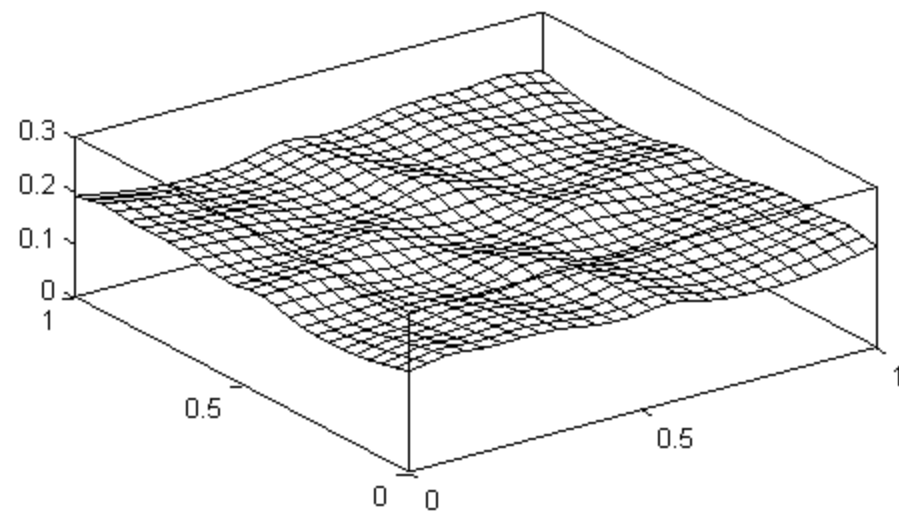

t=2.1 sec

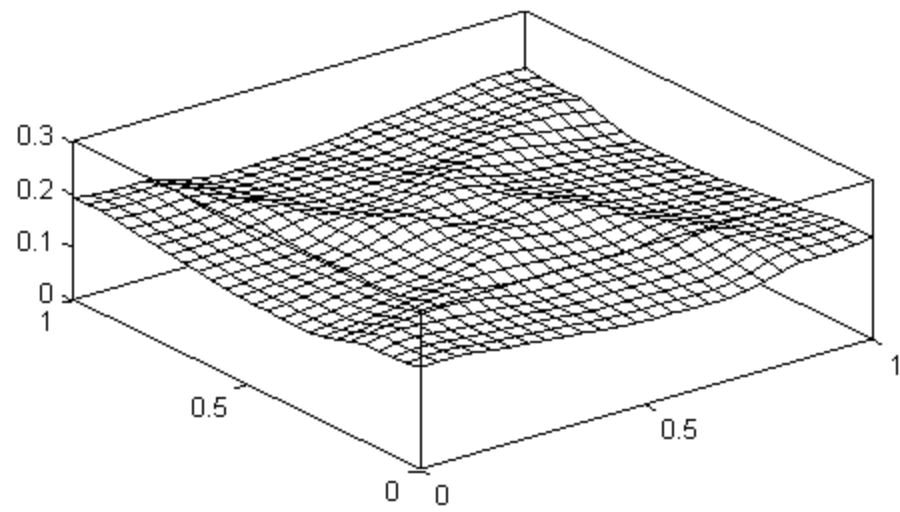

t=2.25 sec

